

Lenovo ThinkSystem ST45 V3 Server Product Guide

The Lenovo ThinkSystem ST45 V3 single-socket tower server is a compact-sized and affordable 1S entry tower design optimized for SOHO (Small Office/Home Office), educational institutions and retail office. The server supports one AMD EPYC 4004 Series processor and up to 64 GB of TruDDR5 5200MHz memory.

Target workloads such as: File server, Mail server, Print server, FTP server, Business Application, Near-side Data Backup

The following figure shows the ThinkSystem ST45 V3.



Figure 1. Lenovo ThinkSystem ST45 V3

[360° View](#)

[Full 3D Tour](#)

Did you know?

The ThinkSystem ST45 V3 offers enterprise-class reliability features such as error correcting code (ECC) memory, enterprise-class hard drives and network adapters at an affordable price. The server supports LXPM Lite for industry-standard setup tool. The ST45 V3 runs a wide range of server operating systems and is quiet enough and small enough to fit under or beside an office desk.

Key features

The ThinkSystem ST45 V3 server is an office-friendly tower server that has been optimized to provide enterprise-class features to small businesses, retail, educational institutions and branch offices.

Scalability and performance

The ST45 V3 offers numerous features to boost performance, improve scalability, and reduce costs:

- Improved single-socket processor performance:
 - AMD EPYC 4004 CPU
 - Up to 12 cores and core speeds up to 3.8 GHz
- Up to two 5200 MHz TruDDR5 UDIMMs provide speed and capacity of up to 64 GB.
- Two PCIe slots for I/O expansion, one PCIe x16 and one PCIe x1.
- Support for NVMe M.2 drive for OS boot operations.
- Support for three 3.5-inch non-hot-swap (NHS) drive bays and one 2.5-inch drive, or, support for two 3.5-inch non-hot-swap (NHS) drive bays, one 2.5-inch drive and one ODD drive. Providing flexible internal storage capacity.
- The use of SSDs instead of, or along with, traditional spinning drives (HDDs) can significantly improve I/O performance.

Availability and serviceability

The ST45 V3 provides many features to simplify serviceability and increase system uptime:

- EPYC 4004 RAS features include on-chip ECC/parity, on-package link CRC, PCIe LCRC, PCIe ECRC, and PCIe uncorrected error detection. Correction of single-bit memory errors and PCIe correctable errors support is limited to the hardware layer and offer no support for WHEA (Windows Hardware Error Architecture) or EDAC (Error Detection And Correction).
- Designed to run 24 hours a day, 7 days a week.
- The server supports UDIMM memory with ECC protection which provides error correction not available in PC-class "servers" that use parity memory. Avoiding system crashes (and data loss) due to soft memory errors means greater system uptime.
- Tool-less cover removal provides easy access to upgrades and serviceable parts, such as memory and adapter cards.
- A choice of affordable onboard SATA RAID or advanced hardware RAID redundancy offers data protection and greater system uptime.
- The use of SSDs can provide better reliability than the use of traditional HDDs, for greater uptime.
- Power-on Self-Test (POST).
- The Lenovo XClarity Provisioning Manager Lite tool can be used to install an operating system on the server and perform system diagnostics.
- One-year or three-year customer-replaceable unit (CRU) and onsite limited warranty with next business day response. Optional service upgrades are available.

Manageability and security

Powerful systems management features simplify local management of the ST45 V3:

- An integrated industry-standard Unified Extensible Firmware Interface (UEFI) enables improved setup, configuration, and updates, and simplifies error handling.
- An integrated hardware Trusted Platform Module (TPM) supporting TPM 2.0 enables advanced cryptographic functionality, such as digital signatures and remote attestation.
- Administrator and power-on passwords help protect from unauthorized access to the server.
- A padlock loop at the rear of the server plus an optional intrusion switch on the cover of the server help detect and prevent unauthorized physical access to the internal components of the server.
- A slot for a Kensington-style cable lock helps prevent theft.

Energy efficiency

The ST45 V3 offers the following energy saving features to save energy, reduce operational costs, increase energy availability, and contribute to a green environment:

- 80 PLUS Platinum-certified power supply (select models) enables greater energy savings while providing flexibility to meet your business needs.
- The ThinkSystem Capacity Planner tool provides information about the power consumption and electric current calculation for the different configurations of servers and other devices, which helps plan deployment of servers and devices in an efficient way.
- Energy [star certification](#).

Comparing the ST45 V3 to ST50 V3

The ThinkSystem ST45 V3 comparison on the current generation ST50, as summarized in the following table.

- 2x UDIMM slots, up to 64 GB, 5200MHz with AMD EPYC 4004 processor
- TruDDR5 ECC memory

Table 1. Comparing the ST45 V3 to ST50 V3

Feature	ST45 V3	ST50 V3	Benefits
Form Factor	<ul style="list-style-type: none"> • 1-Socket (1S) Entry Tower • 17 liter chassis 	<ul style="list-style-type: none"> • 1-Socket (1S) Entry Tower • 17 liter chassis 	<ul style="list-style-type: none"> • Maintains small form factor
Processor	<ul style="list-style-type: none"> • Support single AMD EPYC 4004 CPU processor up to 12C / 65W • AMD PRO 665 chipset 	<ul style="list-style-type: none"> • Support single Xeon E-2400 Series "Raptor Lake" processor up to 8C / 95W • Also supports Pentium processors (Alder Lake) • Intel C266 "Raptor Lake" Platform Controller Hub (PCH-S) 	<ul style="list-style-type: none"> • Supports the latest generation AMD EPYC processors
Memory	<ul style="list-style-type: none"> • 2x UDIMM slots, up to 64GB, 5200MHz with AMD EPYC 4004 CPU processors • TruDDR5 ECC memory 	<ul style="list-style-type: none"> • 4x UDIMM slots, up to 128GB, 4800MHz with Xeon E-2400 processors • 4x UDIMM slots, up to 128GB, 4800MHz with Pentium processor) 	<ul style="list-style-type: none"> • Supports independent mode • Supports higher performance memory

Feature	ST45 V3	ST50 V3	Benefits
Storage	<ul style="list-style-type: none"> Up to 4 bays 2 or 3x 3.5" HDD or SSD; 1x2.5" SSD (optional) 2x M.2 NVMe SSD (optional) 1x slim SATA DVD-RW in dedicated bay (optional) 	<ul style="list-style-type: none"> Up to 4 bays 3x 3.5" HDD or SSD, (1 standard, 2 optional); 1x2.5" SSD (optional) 2x M.2 SATA SSD supporting RAID 0 and RAID 1 using VROC, installs in an adapter in a PCIe slot) 1x slim SATA DVD-RW in dedicated bay (optional) 	<ul style="list-style-type: none"> Support for both HDDs for capacity and SSDs for performance Optical drive support for ease of software installation M.2 drive support to separate the OS from the applications and data
RAID	<ul style="list-style-type: none"> HW RAID support SW RAID support (Planned for Q1/2025) 	<ul style="list-style-type: none"> Supports a SAS HBA or RAID adapter for hardware RAID functionality 12Gb SAS/SATA/RAID support) PCIe 4.0 and PCIe 5.0 adapters Intel VROC 8.x SW RAID (no support for NVMe RAID) 	<ul style="list-style-type: none"> RAID capability maximizes reliability and uptime
Cooling	<ul style="list-style-type: none"> 2x system fans (Front drive bay and rear), 1x CPU fan 	<ul style="list-style-type: none"> 2x system fans (Front drive bay and rear), 1x CPU fan 	<ul style="list-style-type: none"> Ensures all components are sufficiently cooled
Networking	<ul style="list-style-type: none"> 1x 1GbE Embedded (Realtek RTL8111FP) 	<ul style="list-style-type: none"> 2x 1GbE Onboard Ethernet ports (Broadcom BCM572) Rear 1 port allows remote connectivity to the XCC2 management controller 	<ul style="list-style-type: none"> Easy built-in networking
Management	<ul style="list-style-type: none"> TPM embedded: TPM 2.0 Lenovo XClarity Provisioning Manager Lite (USB based) 	<ul style="list-style-type: none"> XClarity Controller with upgrades Full XClarity software suite including XClarity Administrator Dedicated Ethernet port for remote management Optional intrusion switch 	<ul style="list-style-type: none"> TPM 2.0 enables advanced cryptographic functionality, such as digital signatures and remote attestation LXPM Lite provides easy system setup and firmware upgrades
PCIe Slots	<ul style="list-style-type: none"> 2 PCIe slots (x16, x1) 	<ul style="list-style-type: none"> 3 PCIe slots (x4, x16, x4) Includes a PCIe Gen5 x16 slot) 	<ul style="list-style-type: none"> Supports PCIe slot technology Support for a high-performance PCIe x16 adapter
Front I/O	<ul style="list-style-type: none"> Power button & LED Thermal sensor 1x USB 3.2 G1 (5 Gbps) with USB-C connector 2x USB 3.2 G1 (5 Gbps); 2x USB 3.2 G2 (5 Gbps) ports 1x Microphone port, 1x Headset port 	<ul style="list-style-type: none"> One USB 3.2 G1 (5 Gb/s) port One USB 2.0 port (also for XClarity Mobile connectivity for local systems management) 	<ul style="list-style-type: none"> Expansive USB support Thermal sensor ensures the server does not overheat if the ambient temperature rises

Feature	ST45 V3	ST50 V3	Benefits
Rear I/O	<ul style="list-style-type: none"> ● 4x USB 2.0 ● 2x DP1.4 ● 1x HDMI2.1 ● 1x 1GbE LAN ● 1x Audio line out 	<ul style="list-style-type: none"> ● 4x USB 3.2 G1 (5 Gb/s) ports ● One VGA video ● 1x RJ-45 systems management ● 1x RJ-45 GbE network port ● 1x serial port 	<ul style="list-style-type: none"> ● Expansive USB support ● Integrated Gigabit networking
Power Supply	<ul style="list-style-type: none"> ● 1x Fixed power supply ● Choose from 300W Gold or 500W Platinum 	<ul style="list-style-type: none"> ● 1x Fixed power supply ● Choose from 300W Gold or 500W Platinum 	<ul style="list-style-type: none"> ● Select the power supply that best suits the configuration to maximize efficiency

Components and connectors

The following figure shows the front of the server.

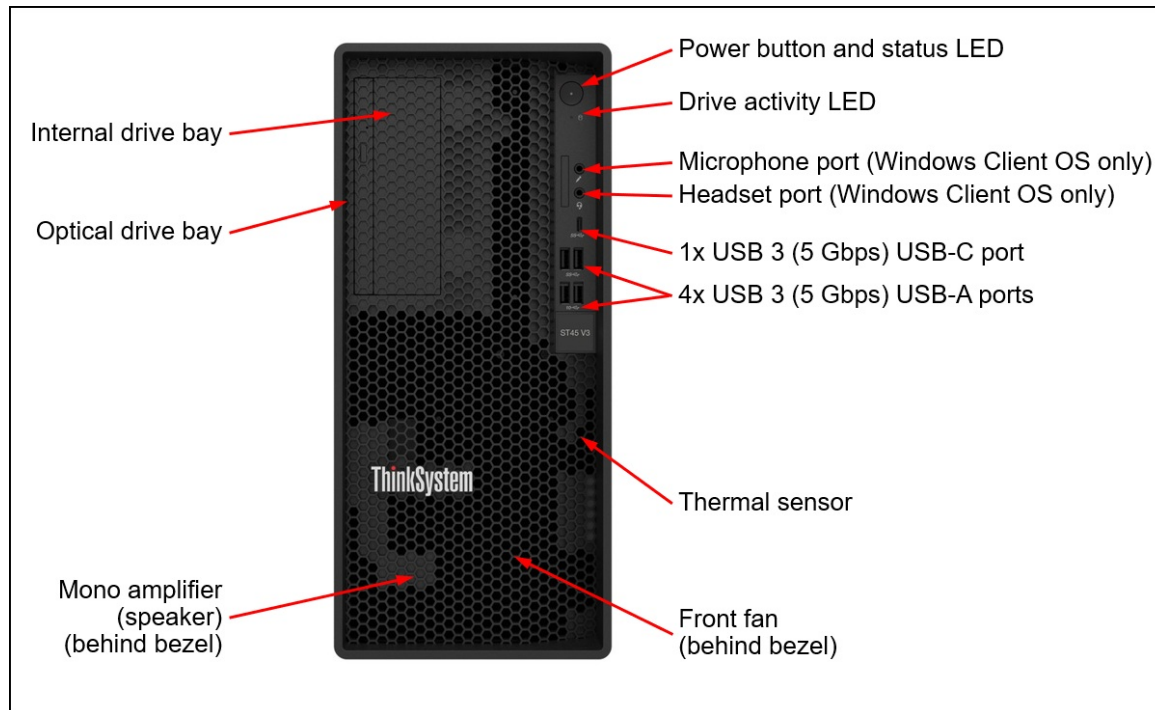

Figure 2. Front view of the ThinkSystem ST45 V3 server

The following figure shows the rear of the server.

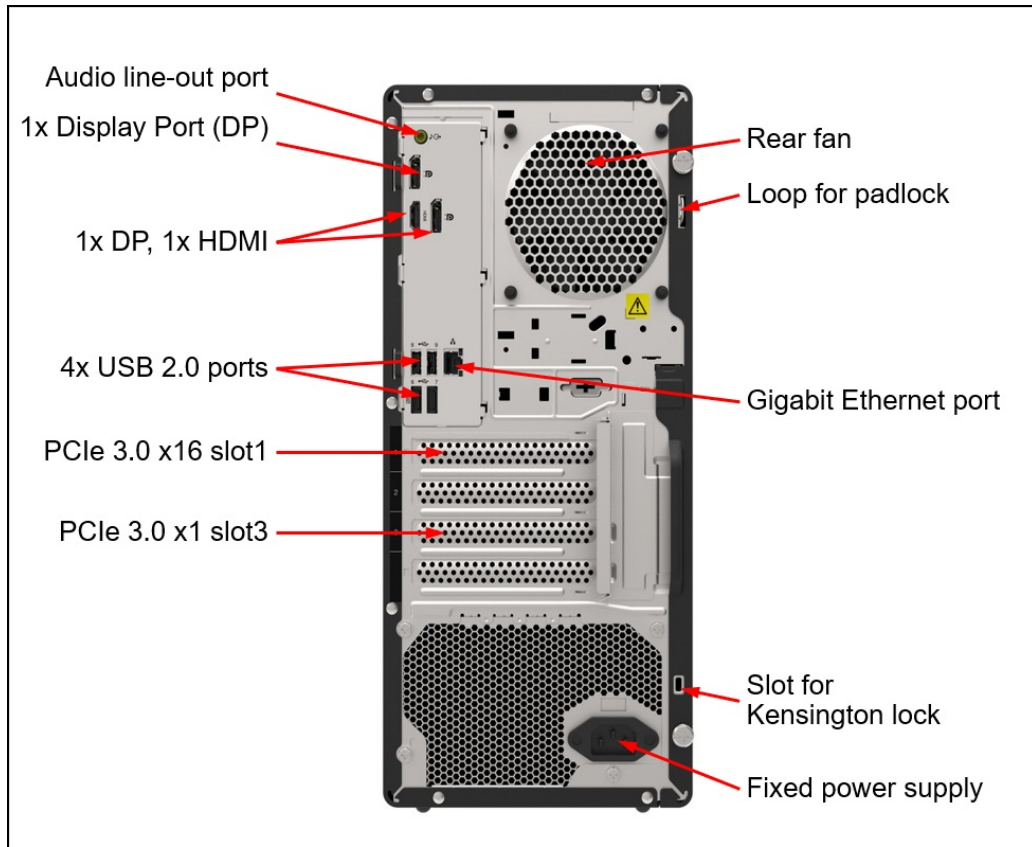

Figure 3. Rear view of the ThinkSystem ST45 V3 server

The following figure shows the locations of key components inside the server. The optical drive bay and drive bays 2 and 3 are removed to show the system board. To view the drive bays, see the [Internal storage](#) section.

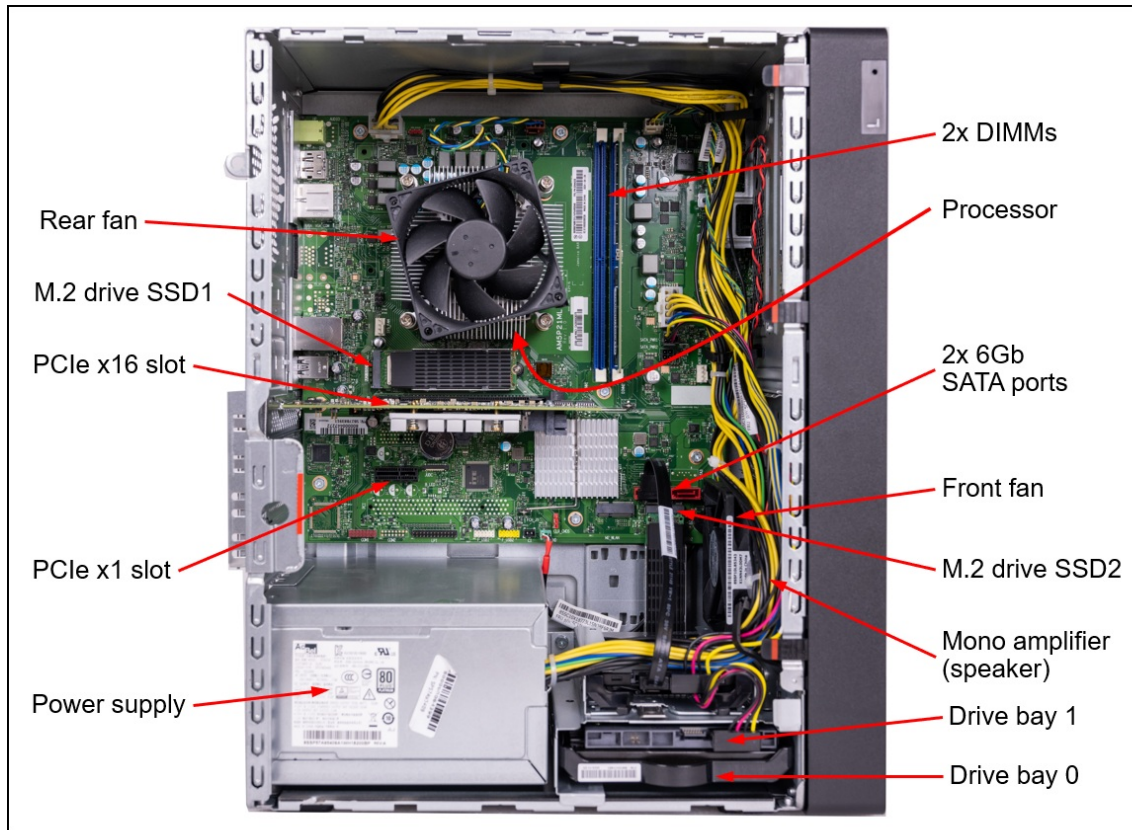

Figure 4. Internal view of the ThinkSystem ST45 V3 server

System architecture

The following figure shows the architectural block diagram of the ST45 V3, showing the major components and their connections.

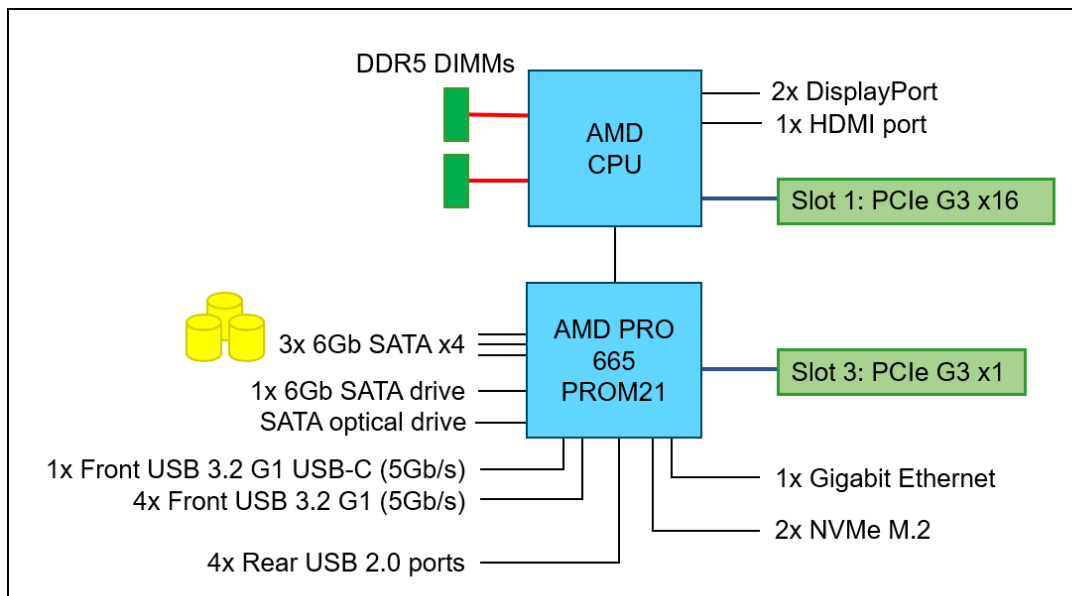

Figure 5. ST45 V3 system architectural block diagram

Standard specifications

The following table lists the standard specifications.

Table 2. Standard specifications

Components	Specification
Machine type	7DH4 - 1 year warranty 7DH5 - 3 year warranty
Form factor	Tower
Processor	One AMD processor. Choose from: <ul style="list-style-type: none"> • AMD EPYC 4004 CPU Support up to 65W with 12 cores, with core speeds up to 3.8 GHz
Chipset	AMD PROM21 Chipset: PRO-665
Memory	Two DIMM sockets supporting Lenovo TruDDR5 DIMMs at 5600 MHz. Support ECC UDIMMs.
Memory maximums	Up to 64 GB using 2x 32 GB UDIMMs.
Memory protection	Error-correcting code (ECC)
Disk drive bays	Up to 4x non-hot swap (NHS) drive bays: <ul style="list-style-type: none"> • 3x 3.5-inch NHS drive bays supporting HDDs or SSDs • 1x 2.5-inch NHS drive bay supporting an SSD <p>The server can be configured with HDDs or SSDs. The server also supports 2x NVMe M.2 drive installed in a socket on the system board as a boot drive.</p>
Maximum internal storage	<ul style="list-style-type: none"> • 3.5-inch drives: <ul style="list-style-type: none"> ◦ 24TB using 3x 8TB 3.5-inch HDDs • 2.5-inch drives: <ul style="list-style-type: none"> ◦ 960GB using 1x 960GB 2.5-inch SATA SSDs <p>HDDs and SSDs can be installed in the same server but are not supported in the same RAID volume</p>
Storage controller	<ul style="list-style-type: none"> • Onboard 6 Gb SATA controller, supporting AHCI mode (non-RAID) • RAID 5350-8i adapter (for 3x 3.5" HDD) • 4350-8i SAS/SATA 12Gb HBA • AMD software RAID (Planned for 1Q/2025)
Optical drive	Optional slim DVD-RW drive in dedicated bay.
Network interfaces	One integrated Gigabit Ethernet 1000BASE-T port (RJ-45), Realtek RTL8111FP.
PCI Expansion slots	Two PCIe slots as follows: <ul style="list-style-type: none"> • Slot 1: PCIe 3.0 x16 full-height half-length (FHHL) (75W) • Slot 3: PCIe 3.0 x1 full-height half-length (FHHL) (25W)

Components	Specification
Ports	<p>Front ports:</p> <ul style="list-style-type: none"> ● Five USB ports <ul style="list-style-type: none"> ○ 1x USB 3 (5 Gb/s) with USB-C connector ○ 4x USB 3 (5 Gb/s) with USB-A connector ● Microphone port* ● Headset port* <p>Rear ports:</p> <ul style="list-style-type: none"> ● Four USB 2.0 ports ● Two DisplayPort 1.4 video ports ● One HDMI 2.1 ● One RJ-45 Gigabit Ethernet port ● One audio line-out port* <p>* Windows 11 only; some line noise is possible</p>
Audio	Mono amplifier (speaker) mounted on the inside of the front bezel; Audio line-out port at the rear of the server; microphone and headset ports at the front of the server
Cooling	Two fixed system fans. One CPU heat sink fan. Supports ASHRAE A2 environments.
Power supply	Model dependent choices <ul style="list-style-type: none"> ● One fixed 300W Gold power supply ● One fixed 500W Platinum power supply: Energy Star and ErP Lot 9 compliant.
Hot-swap parts	None
Systems management	Power and drive activity LEDs. Supports Lenovo XClarity Provisioning Manager Lite (USB memory key-based) for system setup and firmware upgrades. No support for XClarity Controller (XCC).
Security features	Power-on password, administrator's password, Trusted Platform Module (TPM), supporting TPM 2.0. Optional Chassis intrusion switch. Padlock loop and Kensington cable slot for physical security.
Video	Two DisplayPort ports and native HDMI support resolution (4K) at a refresh rate of 60Hz.
Operating systems supported	Microsoft Windows Server, Red Hat Enterprise Linux, SUSE, Ubuntu, Windows 11 tested. See the Operating system support section for specifics.
Limited warranty	Three-year or one-year (model dependent) customer-replaceable unit and onsite limited warranty with 9x5 next business day (NBD).
Service and support	Optional service upgrades are available through Lenovo Services: 4-hour or 2-hour response time, 6-hour fix time, 1-year or 2-year warranty extension, software support for Lenovo hardware and some third-party applications.
Dimensions	Width: 170 mm (6.7 in.), height: 376 mm (14.8 in.), depth: 316 mm (12.4 in.). See Physical and electrical specifications for details.
Weight	Maximum: 8.56 kg (18.90 lb)

The server is shipped with the following items:

- Documentation flyer
- Power cord (model and region dependent)

Models

ThinkSystem ST45 V3 models can be configured by using the [Lenovo Data Center Solution Configurator \(DCSC\)](#).

Configure-to-order (CTO) models are used to create models with factory-integrated server customizations. For CTO models, two types of base CTO models are available for the ST45 V3 as listed in the columns in the following table:

- General purpose base CTO models are for general business (non-HPC) and is selectable by choosing **General Purpose** mode in DCSC.
- AI and HPC base models are intended for Artificial Intelligence (AI) and High Performance Computing (HPC) configurations and solutions are enabled using the **AI & HPC Hardware - ThinkSystem Hardware** mode in DCSC. These configurations, along with Lenovo EveryScale Solutions, can also be built using [System x and Cluster Solutions Configurator \(x-config\)](#). **Tip:** Some HPC and AI models are not listed in DCSC and can only be configured in x-config.

Preconfigured server models may also be available for the ST45 V3, however these are region-specific; that is, each region may define their own server models, and not all server models are available in every region.

The following table lists the base CTO models of the ThinkSystem ST45 V3 server.

Table 3. Base CTO models

Machine Type/Model General purpose	Machine Type/Model for AI and HPC	Description
7DH5CTO1WW	7DH5CTOLWW	ThinkSystem ST45 V3 – 3-year warranty
7DH4CTO1WW	7DH4CTOLWW	ThinkSystem ST45 V3 – 1-year warranty

The following tables list the available models, grouped by region.

- [Models for Asia Pacific region](#)
- [Models for Brazil](#)
- [Models for EMEA region](#)
- [Models for Latin American countries \(except Brazil\)](#)
- [Models for USA and Canada](#)

Refer to the Specifications section for information about standard features of the server.

Models for Asia Pacific region

The following table lists the models for the Asia Pacific region: Australia, Bangladesh, Brunei, Hong Kong, India, Japan, Korea, Sri Lanka, Malaysia, New Zealand, Philippines, Singapore, Thailand, Taiwan, Vietnam

Table 4. Models for Asia Pacific markets

Model	AMD processors†	Memory	Drive Contr	Drive bays	DVD	Cards	Power supply & cord	Power cord	Video port
TopSeller models with a 3-year warranty (machine type 7DH5)									
7DH5A00XAP	4244P 6C/3.8G/65W	1x 16GB	OB SATA / AHCI	2x3.5" bay; Open bay	No	Opt	300W	No	Yes
7DH5A00YAP	4124P 4C/3.8G/65W	1x 16GB	OB SATA / AHCI	2x3.5" bay; Open bay	No	Opt	300W	No	Yes
7DH5A00WAP	4464P 12C/3.7G/65W	1x 16GB	OB SATA / AHCI	2x3.5" bay; Open bay	No	Opt	300W	No	Yes
7DH5A00FAP	4344P 8C/3.8G/65W	1x 16GB	OB SATA / AHCI	2x3.5" bay; Open bay	No	Opt	300W	No	Yes

† Processor description: Processor model, number of cores, core frequency, thermal design power (TDP)

Models for Brazil

Table 5. Models for Brazil

Model	AMD processors†	Memory	Drive Contr	Drive bays	DVD	Cards	Power supply	Power cord	Video port
Standard models with a 3-year warranty (machine type 7DH5)									
7DH5A014BR	4124P 4C/3.8G/65W	1x 16GB	OB SATA / AHCI	2x3.5" bay; 2x 2TB SATA HDD	Opt	Opt	300W	Yes	Yes
7DH5A013BR	4124P 4C/3.8G/65W	1x 16GB	OB SATA / AHCI	2x3.5" bay; 1x 2TB SATA HDD	Opt	Opt	300W	Yes	Yes
7DH5A010BR	4124P 4C/3.8G/65W	1x 16GB	OB SATA / AHCI	2x3.5" bay; 1x 1TB SATA HDD	Opt	Opt	300W	Yes	Yes
7DH4A007BR	4124P 4C/3.8G/65W	1x 16GB	OB SATA / AHCI	2x3.5" bay; 2x 1TB SATA HDD	Opt	Opt	300W	Yes	Yes

† Processor description: Processor model, number of cores, core frequency, thermal design power (TDP)

Models for EMEA region

Table 6. Models for EMEA region

Model	AMD processors†	Memory	Drive Contr	Drive bays	DVD	Cards	Power supply	Power cord	Video port
Standard models with a 3-year warranty (machine type 7DH5)									
7DH5A00CEA	4344P 8C/3.8G/65W	1x 32GB	OB SATA / AHCI	2x3.5" bay; 2x 960GB SATA HDD	Opt	Opt	500W	Yes	Yes
7DH5A00EEA	4344P 8C/3.8G/65W	1x 16GB	OB SATA / AHCI	2x3.5" bay; 2x 2TB SATA HDD	Opt	Opt	500W	Yes	Yes
7DH5A00HEA	4464P 12C/3.7G/65W	1x 32GB	OB SATA / AHCI	2x3.5" bay; 2x 2TB SATA HDD	Opt	Opt	500W	Yes	Yes
7DH5A00JEA	4244P 6C/3.8G/65W	1x 32GB	OB SATA / AHCI	2x3.5" bay; 2x 480GB SATA HDD	Opt	Opt	500W	Yes	Yes
7DH5A00GEA	4244P 6C/3.8G/65W	1x 16GB	OB SATA / AHCI	2x3.5" bay; 2x 960GB SATA HDD	Opt	Opt	500W	Yes	Yes
7DH5A00BEA	4124P 4C/3.8G/65W	1x 16GB	OB SATA / AHCI	2x3.5" bay; 2x 480GB SATA HDD	Opt	Opt	500W	Yes	Yes
7DH5A00AEA	4244P 6C/3.8G/65W	1x 16GB	OB SATA / AHCI	2x3.5" bay; 2x 2TB SATA HDD	Opt	Opt	500W	Yes	Yes
7DH5A006EA	4124P 4C/3.8G/65W	1x 16GB	OB SATA / AHCI	2x3.5" bay; 2x 2TB SATA HDD	Opt	Opt	500W	Yes	Yes
7DH5A005EA	4464P 12C/3.7G/65W	1x 16GB	OB SATA / AHCI	2x3.5" bay; 2x 960GB SATA HDD	Opt	Opt	500W	Yes	Yes
7DH5A008EA	4124P 4C/3.8G/65W	1 32GB	OB SATA / AHCI	2x3.5" bay; 2x 960GB SATA HDD	Opt	Opt	500W	Yes	Yes
7DH5A007EA	4124P 4C/3.8G/65W	1x 16GB	IOB SATA / AHC	2x3.5" bay; 2x 960GB SATA HDD	Opt	Opt	500W	Yes	Yes
7DH5A009EA	4124P 4C/3.8G/65W	1x 32GB	OB SATA / AHCI	2x3.5" bay; 2x 2TB SATA HDD	Opt	Opt	500W	Yes	Yes
7DH5A00UEA	4464P 12C/3.7G/65W	1x 32GB	OB SATA / AHCI	2x3.5" bay; 2x 960GB SATA HDD	Opt	Opt	500W	Yes	Yes
7DH5A00SEA	4124P 4C/3.8G/65W	1x 16GB	OB SATA / AHCI	2x3.5" bay; 2x 1TB SATA HDD	Opt	Opt	500W	Yes	Yes
7DH5A00TEA	4244P 6C/3.8G/65W	1x 16GB	OB SATA / AHCI	2x3.5" bay; 2x 480GB SATA HDD	Opt	Opt	500W	Yes	Yes
7DH5A00MEA	4344P 8C/3.8G/65W	1x 16GB	OB SATA / AHCI	2x3.5" bay; 2x 960GB SATA HDD	Opt	Opt	500W	Yes	Yes
7DH5A00NEA	4344P 8C/3.8G/65W	1x 32GB	OB SIATA / AHCI	2x3.5" bay; 2x 2TB SATA HDD	Opt	Opt	500W	Yes	Yes
7DH5A00KEA	4344P 8C/3.8G/65W	1x 32GB	OB SATA / AHCI	2x3.5" bay; 2x 480GB SATA HDD	Opt	Opt	500W	Yes	Yes
7DH5A00LEA	4464P 12C/3.7G/65W	1x 32GB	OB SATA / AHCI	2x3.5" bay; 2x 4TB SATA HDD	Opt	Opt	500W	Yes	Yes
7DH5A00QEA	4244P 6C/3.8G/65W	1x 16GB	OB SATA / AHCI	2x3.5" bay; 2x 1TB SATA HDD	Opt	Opt	500W	Yes	Yes
7DH5A00REA	4244P 6C/3.8G/65W	1x 32GB	OB SATA / AHCI	2x3.5" bay; 2x 960GB SATA HDD	Opt	Opt	500W	Yes	Yes
7DH5A00PEA	4244P 6C/3.8G/65W	1x 32GB	OB SATA / AHCI	2x3.5" bay; 2x 2TB SATA HDD	Opt	Opt	500W	Yes	Yes

† Processor description: Processor model, number of cores, core frequency, thermal design power (TDP)

Models for Latin American countries (except Brazil)

Table 7. Models with a 3-year warranty for Latin American countries (except Brazil)

Model	AMD processors†	Memory	Drive Contr	Drive bays	DVD	Cards	Power supply	Power cord	Video port
TopSeller models with a 3-year warranty (machine type 7DH5)									
7DH5A00ZLA	4124P 4C/3.8G/65W	1x 16GB	OB SATA / AHCI	2x3.5" bay; Open bay; 1x 1TB SATA HDD	Opt	Opt	300W	Yes	Yes
7DH5A015LA	4124P 4C/3.8G/65W	1x 16GB	OB SATA / AHCI	2x3.5" bay; Open bay; 1x 1TB SATA HD	Opt	Opt	500W	Yes	Yes
7DH5A016LA	4124P 4C/3.8G/65W	1x 16GB	OB SATA / AHCI	2x3.5" bay; Open bay; 2x 1TB SATA HD	Opt	1x 4pt 1Gb	300W	Yes	Yes
7DH5A011LA	4244P 6C/3.8G/65W	1x 32GB	OB SATA / AHCI	2x3.5" bay; Open bay; 1x 1TB SATA HD	Opt	Opt	300W	Yes	Yes
7DH5A012LA	4244P 6C/3.8G/65W	1x 32GB	OB SATA / AHCI	2x3.5" bay; Open bay; 2x 1TB SATA HD	Opt	Opt	500W	Yes	Yes

† Processor description: Processor model, number of cores, core frequency, thermal design power (TDP)

Models for USA and Canada

Table 8. Models for USA and Canada

Model	AMD processors†	Memory	Drive Contr	Drive bays	DVD	Cards	Power supply	Power cord	Video port
Standard models with a 3-year warranty (machine type 7DH5)									
7DH5A00DNA	4124P 4C/3.8G/65W	1x 16GB	OB SATA / AHCI	2x3.5" bay; Open bay	Opt	Opt	300W	Yes	Yes

† Processor description: Processor model, number of cores, core frequency, thermal design power (TDP)

Processors

The ST45 V3 supports one AMD EPYC 4004 series processor, up to 12 cores and 65W TDP.

All supported processors have the following characteristics:

- Supports AMD PRO 665 chipset (PROM21)
- Support for ECC memory
 - Two DDR5 memory channels
- PCIe lanes

The following table lists the supported processors.

Table 9. AMD supported processors

Feature code	AMD model	TDP	Cores/threads	Core speed	Cache	Max memory speed
C1G9	4464P	65W	12 / 24	3.7 GHz	64 MB	5200 MHz
C1G0	4344P	65W	8 / 16	3.8 GHz	32 MB	5200 MHz
C1GB	4244P	65W	6 / 12	3.8 GHz	32 MB	5200 MHz
C4E0	4124P	65W	4 / 8	3.8 GHz	16 MB	5200 MHz

Memory options

The ST45 V3 supports Lenovo TruDDR5 memory. TruDDR5 memory uses the highest-quality components sourced from Tier 1 DRAM suppliers and only memory that meets strict requirements is selected. It is compatibility-tested and tuned to maximize performance and reliability.

TruDDR5 memory has a unique signature programmed into the DIMM, which enables ThinkSystem servers to verify whether the memory installed is qualified and supported. From a service and support standpoint, TruDDR5 memory automatically assumes the system's warranty, and service and support provided worldwide.

The processors have 2 memory channels and support 1 DIMM per channel. The ST45 V3 supports 1 or 2 DIMMs. Both DIMMs installed must be identical.

DIMMs installed in the ST45 V3 operate at a speed based on the processor installed.

The following table lists the memory options that are available for the ST45 V3 server.

Table 10. ST45 V3 server memory section

Part number	Feature code	Description	Maximum supported
4X77A93557	C1G6	ThinkSystem 32GB TruDDR5 5600MHz (2Rx8) ECC UDIMM-A	2
4X77A93556	C1G7	ThinkSystem 16GB TruDDR5 5600MHz (1Rx8) ECC UDIMM-A	2

The following rules apply when selecting the memory configuration:

- The server only supports UDIMMs
- Quantities of 1 or 2 DIMMs are supported
- Both DIMMs must be identical (same part number)
- When installing two DIMMs, install one in each memory channel
- Memory mirroring and memory rank sparing are not supported

Internal storage

The ST45 V3 supports up to three 3.5-inch drives non-hot-swap drives and one 2.5-inch. The system also supports an 9mm slim SATA optical disk drive.

Server comes standard with one empty cage drive for bay 0. All bays 0, 1, 2, 3 support optional drives.

Topics in this section:

- [Drive bays](#)
- [M.2 drives](#)
- [Field upgrades](#)

For information about the optical drive, see the [Optical drives](#) section.

Drive bays

The drive bays are as follows:

- Drive bay 0: 3.5-inch HDD or SSD, non-hot-swap (standard with the server)
- Drive bay 1: 2.5-inch SSD, non-hot-swap, optional
- Drive bay 2: 3.5-inch HDD or SSD, non-hot-swap, optional
- Drive bay 3: 3.5-inch HDD or SSD, non-hot-swap, optional

The supported internal drive bays are:

- Option 1: 2x 3.5" + 1x 2.5" + 1x ODD
- Option 2: 3x 3.5" + 1x 2.5" (no ODD)
- 2x NVMe M.2 support

The following image shows location for drive bays option 1 and option 2.

Note: Drive bays 0, 1, 2 and 3 are only accessible from the side of the server.

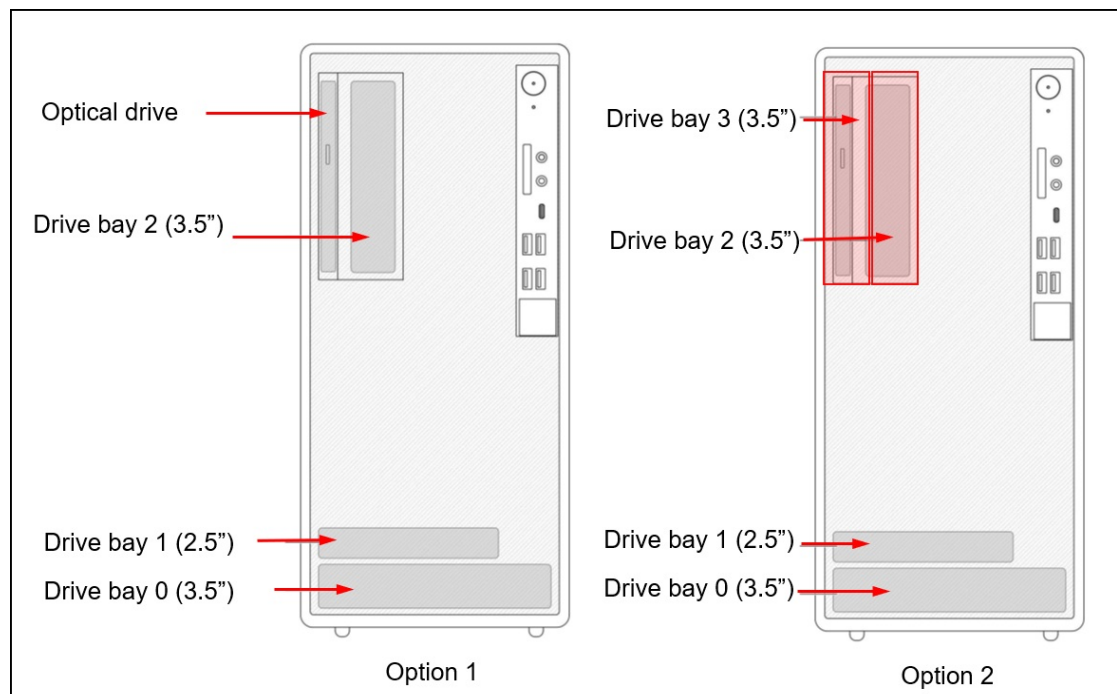

Figure 6. ST45 V3 drive bays (front view)

The following figure shows the internals of the server with the drive bays and optical drive installed.

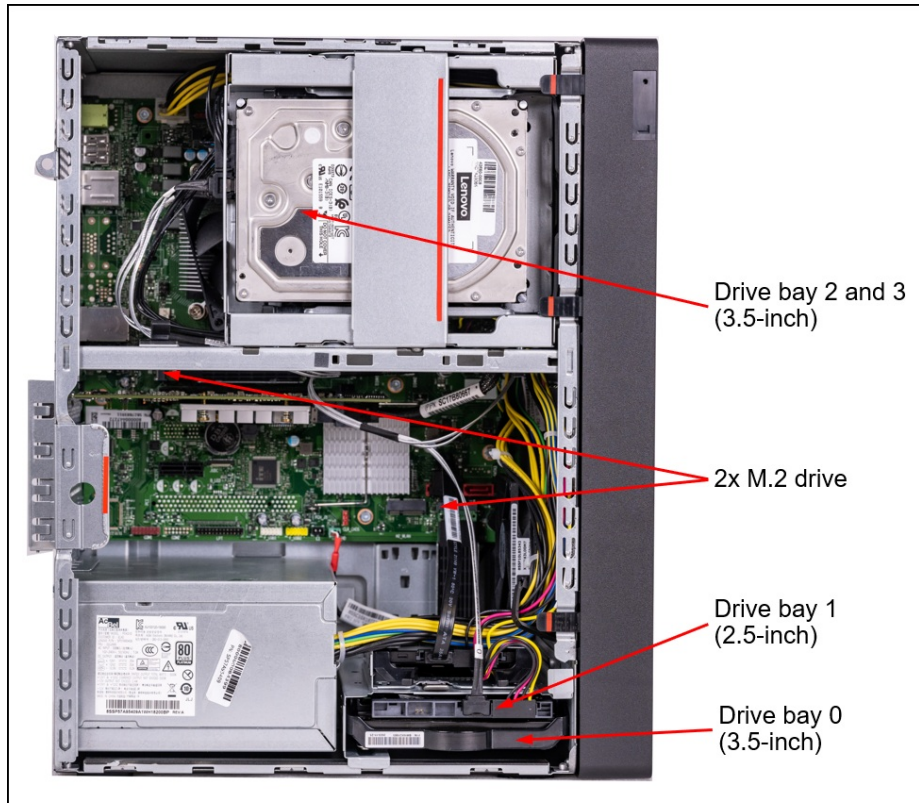

Figure 7. ST45 V3 drive bays (side view)

Drive bays 1, 2 and 3 are optional. For CTO orders, the following table lists the ordering information to configure these bays.

Use of Client HDDs and Bay 2: As described in the [Special Notice for Client drives](#) section, Client HDDs cannot be in the server along with other drive types. The impact of this rule is that in CTO orders, the 2.5-inch drive bay (Bay 2) is not selectable if you select any client HDDs.

Table 11. Drive bays

Part number	Feature code	Description
4XF7A78617*	BME0	ThinkSystem ST50/ST45 Series 2.5" HDD Cage Kit Bracket to mount a 2.5-inch drive to drive bay 1
4XF7A96626*	BME1 / BMEX	ThinkSystem ST45 V3 1x3.5" HDD+ODD Cage Kit Bracket to mount a 3.5-inch drive to drive bay 2 + ODD
4XF7A96625*	C1G1 / C1G2	ThinkSystem ST45 V3 2x 3.5" HDD Cage Kit Bracket to mount a 3.5-inch drive to drive bay 2, bay 3

* The option part number includes SATA and power cables. See [Field upgrades](#) for details.

M.2 drives

The ST45 V3 supports two internal NVMe M.2 drives. See the Internal view of the server ([link to Figure 4](#)) for the location of the two M.2 drives, SSD1 and SSD2. Ordering information for the SSD2 bracket is listed in the following table.

Tip: Only M.2 2280 form factor drives are supported. Other M.2 form factors are not supported.

Table 12. Field upgrade options for M.2 drives

Part number	Feature code	Description
4XF7A79661	BMEK	ThinkSystem ST50 V2/ST45 V3 NVMe M.2 Bracket Kit
4XF7A96627	C1J7	ThinkSystem ST45 V3 M.2 Screw Kit

Configuration requirements:

- For the SSD1 the required screw is derived by the configurator DCSC
- For the SSD2 the required screw and bracket are derived by the configurator DCSC
- Bracket (BMEK) is needed for SSD2 only

Supported M.2 drives are listed in the [Internal drive options](#) section.

Field upgrades

The ST45 V3 supports the following upgrades:

- Add drives to a zero drive (drive-less) server
- Add a RAID adapter or HBA to replace the onboard SATA drive controller
- Add drive bays
- Add an optical drive, as described in the [Optical drives](#) section

If you are planning to do a field upgrade of a server without drives to add drives that connect to the onboard SATA controller, you will need the power cables from the ThinkSystem ST50 V3/ST45 V3 Internal Drive Cable Kit, 4X97A93517, plus the SATA cables that are included in each drive option.

If you are planning to do a field upgrade to add a RAID adapter or HBA, you will need the cables from ThinkSystem ST50 V3/ST45 V3 Internal Drive Cable Kit, 4X97A93517, The MiniSAS data cable in the kit will replace the SATA data cables to all three drives. Use the power cables if you are upgrading from a server without any drives otherwise use the existing power cables already installed.

The following table lists the ordering information.

Table 13. Field upgrades

Part number	Description	Purpose
Drive bay field upgrades		
4XF7A78617	ThinkSystem ST50/ST45 Series 2.5 HDD Cage Kit, contains: <ul style="list-style-type: none"> • Cage to mount a 2.5-inch drive to drive bay 1 (SBB7A46043) 	Add drive bay 1
4XF7A96626	ThinkSystem ST45 V3 1x3.5 HDD+ODD Cage Kit, contains: <ul style="list-style-type: none"> • Cage to mount a 3.5-inch drive to drive bay 2 (SBB7A88134) • 520mm SATA cable for drive bay 2 (SBB7A46040) • Power cable for drive bay 2 (SBB7A46039) 	Add drive bay 2 Requires the rear system fan and the optical drive cage (with or without the optical drive installed).
Cable kit for field upgrades		
4X97A93517	ThinkSystem ST50 V3/ST45 V3 Internal Drive Cable Kit	Cables used in two scenarios: <ul style="list-style-type: none"> • When adding drives to a server with drive bays (cages) but without any drives installed • When upgrading from onboard SATA to an HBA or RAID adapter

Controllers for internal storage

The ST45 V3 has 2x onboard SATA ports supporting AHCI (JBOD) mode (for 2x 3.5-inch drives) RAID support on the onboard ports is planned.

Alternatively, advanced RAID support or HBA support is available with the addition of a RAID adapter or HBA as listed in the following table.

Table 14. Adapters for internal storage

Part number	Feature code	Description	Slots supported	Maximum supported
Adapters				
4Y37A72482	BJHK	ThinkSystem RAID 5350-8i PCIe 12Gb Adapter	1	1
4Y37A72480	BJHH	ThinkSystem 4350-8i SAS/SATA 12Gb HBA	1	1

For a comparison of the functions of the supported storage adapters, see the ThinkSystem RAID Adapter and HBA Reference:

<https://lenovopress.lenovo.com/lp1288-thinksystem-raid-adapter-and-hba-reference>

Internal drive options

The ST45 V3 supports optionally up to three 3.5-inch non-hot-swap drives and optionally one 2.5-inch non-hot-swap drive.

Each drive option part number includes:

- Tray to mount the drive in the server
- 185mm SATA signal cable to connect the drive (when installed in bay 1 or 2) to the onboard SATA controller on the system board.

For CTO orders, the necessary cables and trays will be derived by the configurator.

The following tables list the drive options for internal storage of the server.

Simple-swap drives:

- [2.5-inch simple-swap 6 Gb SATA SSDs](#)
- [3.5-inch simple-swap 6 Gb SATA HDDs](#)
- [3.5-inch simple-swap 6 Gb SATA SSDs](#)

M.2 drives:

- [M.2 PCIe 4.0 NVMe drives](#)

M.2 drive support: The use of M.2 drives requires an additional adapter as described in the [M.2 drives](#) subsection.

SED support: The tables include a column to indicate which drives support SED encryption. The encryption functionality can be disabled if needed. Note: Not all SED-enabled drives have "SED" in the description.

Table 15. 2.5-inch simple-swap 6 Gb SATA SSDs

Part number	Feature code	Description	SED support	Max Qty
2.5-inch simple-swap SSDs - 6 Gb SATA - Read Intensive/Entry (<3 DWPD)				
4XB7A82273	BR0S	ThinkSystem ST50/ST45 Series 2.5" 5400 PRO 240GB Read Intensive SATA 6Gb NHS SSD	Support	1
4XB7A82274	BR0R	ThinkSystem ST50/ST45 Series 2.5" 5400 PRO 480GB Read Intensive SATA 6Gb NHS SSD	Support	1
4XB7A82275	BR0Q	ThinkSystem ST50/ST45 Series 2.5" 5400 PRO 960GB Read Intensive SATA 6Gb NHS SSD	Support	1
4XB7A77459	BMEB	ThinkSystem ST50/ST45 Series 2.5" S4520 240GB Read Intensive SATA 6Gb NHS SSD	No	1
4XB7A77460	BMEA	ThinkSystem ST50/ST45 Series 2.5" S4520 480GB Read Intensive SATA 6Gb NHS SSD	No	1
4XB7A77461	BME9	ThinkSystem ST50/ST45 Series 2.5" S4520 960GB Read Intensive SATA 6Gb NHS SSD	No	1

Table 16. 3.5-inch simple-swap 6 Gb SATA HDDs

Part number	Feature code	Description	SED support	Max Qty
3.5-inch simple-swap HDDs - 6 Gb NL SATA				
4XB7A77445	BMED	ThinkSystem ST50/ST45 Series 3.5" 1TB 7.2K SATA 6Gb Non-Hot Swap 512n HDD	No	3
4XB7A77446	BMEC	ThinkSystem ST50/ST45 Series 3.5" 2TB 7.2K SATA 6Gb Non-Hot Swap 512n HDD	No	3
4XB7A77447	BMEG	ThinkSystem ST50/ST45 Series 3.5" 4TB 7.2K SATA 6Gb Non-Hot Swap 512n HDD	No	3
4XB7A77448	BMEF	ThinkSystem ST50/ST45 Series 3.5" 6TB 7.2K SATA 6Gb Non-Hot Swap 512e HDD	No	3
4XB7A77449	BMEE	ThinkSystem ST50/ST45 Series 3.5" 8TB 7.2K SATA 6Gb Non-Hot Swap 512e HDD	No	3
4XB7A77450	BMEJ	ThinkSystem ST50/ST45 Series 3.5" 1TB Client 7.2K SATA 6Gb Non-Hot Swap 512e HDD	No	3*
4XB7A77451	BMEH	ThinkSystem ST50/ST45 Series 3.5" 2TB Client 7.2K SATA 6Gb Non-Hot Swap 512e HDD	No	3*

* Support for client drives has special conditions of use. See [Special Notice for Client drives](#) for details

Table 17. 3.5-inch simple-swap 6 Gb SATA SSDs

Part number	Feature code	Description	SED support	Max Qty
3.5-inch simple-swap SSDs - 6 Gb SATA - Read Intensive/Entry (<3 DWPD)				
4XB7A82276	BR0P	ThinkSystem ST50/ST45 Series 3.5" 5400 PRO 240GB Read Intensive SATA 6Gb NHS SSD	Support	3
4XB7A82277	BR0N	ThinkSystem ST50/ST45 Series 3.5" 5400 PRO 480GB Read Intensive SATA 6Gb NHS SSD	Support	3
4XB7A82278	BR0M	ThinkSystem ST50/ST45 Series 3.5" 5400 PRO 960GB Read Intensive SATA 6Gb NHS SSD	Support	3
4XB7A77454	BME2	ThinkSystem ST50/ST45 Series 3.5" S4520 240GB Read Intensive SATA 6Gb NHS SSD	No	3
4XB7A77455	BME6	ThinkSystem ST50/ST45 Series 3.5" S4520 480GB Read Intensive SATA 6Gb NHS SSD	No	3
4XB7A77456	BME5	ThinkSystem ST50/ST45 Series 3.5" S4520 960GB Read Intensive SATA 6Gb NHS SSD	No	3

Table 18. M.2 PCIe 4.0 NVMe drives

Part number	Feature code	Description	SED support	Max Qty
M.2 SSDs - PCIe 4.0 NVMe - Read Intensive/Entry (<3 DWPD)				
4XB7A83139	BS46	ThinkSystem M.2 7450 PRO 480GB Read Intensive NVMe PCIe 4.0 x4 NHS SSD (with Heatsink)	Support	2
4XB7A82674	BQUJ	ThinkSystem M.2 7450 PRO 960GB Read Intensive NVMe PCIe 4.0 x4 NHS SSD (with Heatsink)	Support	2

Special notice for Client drives

Some servers support both Client HDDs and Enterprise Class HDDs. Client HDDs are designed for 8x5 operating environment whereas Enterprise Class HDDs are designed for 24x7 operating environment. Selecting the correct drive class will enable the critical areas of quality, functionality, performance, and reliability to be optimized for the target implementation.

When using Client Hard Disk Drives, you agree to the following terms of service:

- Update the firmware once you receive the server according to the "Lenovo Client HDD Upgrade for Windows and Linux" document in the download page:
<https://datacentersupport.lenovo.com/products/servers/thinksystem/st50/7y48/downloads/driver-list/component?name=Storage>
- The use of the Lenovo Online SAS/SATA Hard Disk Drive Update Program is not supported.
- Maximum of 2 Client HDDs per server is supported
- Mixing Client HDDs with other drives is not supported.
- Only supported connected to the server's onboard 6Gbps SATA controller. RAID adapters and HBAs are not supported.
- Operational availability: 8 hours/day, 5 days/week.
- Workload rate limit: < 55 TB/year*

Choosing the right drive type depends on the usage pattern. Improper use of Client HDDs (such as the workload rate exceeding 55 TB/year) will lead to significant risk and increase the drives failure rate.

* The specifications for the product assumes the I/O workload does not exceed the average annualized workload rate limit of 55 TB/year. Workloads exceeding the annualized rate may degrade and impact reliability as experienced by the particular application. The average annualized workload rate limit is in units of TB per calendar year.

Internal backup units

The ST45 V3 does not support any internal backup unit, such as a tape drive or RDX drive.

Optical drives

The ST45 V3 optionally supports an internal optical drive. CTO ordering information is listed in the following table.

Table 19. Internal optical drive

Feature code	Description
Optical drive	
BMEU	ThinkSystem ST50/ST45 Series 9mm-Slim SATA DVD-RW
CTO features	
BMEX	ThinkSystem ST50 V2/V3 Slim ODD Cage Kit - Bracket to mount the optical drive
BMEW	ThinkSystem ST50 V2/V3 Slim ODD Bezel Kit - Front bezel for the optical drive
BMEV	ThinkSystem ST50 V2/V3 W/O Slim ODD Bezel Kit - Front bezel when no optical drive is configured

To add the optical drive as a field upgrade, use the parts listed in the following table.

Table 20. Optical drive field upgrades

Part number	Description	Purpose
4XA7A77462	ThinkSystem ST50/ST45 Series 9mm-Slim SATA DVD-RW, contains: <ul style="list-style-type: none"> Optical drive - ThinkSystem ST50 V2 9mm-Slim SATA DVD-RW (SBB7A45066) 520mm SATA cable for optical drive (SBB7A46040) Power cable for Drive bay 3 and optical drive (SBB7A46041) Bezel for optical drive (SBB7A46134) 	To add the optical drive, cables and front bezel. Requires the optical drive cage

The optical drive is based on the HLDS Model GUE1N Super Multi DVD Writer and supports the following formats:

- DVD-ROM, DVD-ROM DL, DVD-R, DVD-R DL, DVD-RW, DVD-RAM, DVD+R, DVD+R DL, DVD+RW
- CD-ROM, CD-ROM XA, CD-I, Video CD, CD-Audio, CD-Extra, CD-Text, CD-R, CD-RW

External optical drive

The server supports the external USB optical drive listed in the following table.

Table 21. External optical drive

Part number	Feature code	Description
7XA7A05926	AVV8	ThinkSystem External USB DVD RW Optical Disk Drive

The drive is based on the Lenovo Slim DVD Burner DB65 drive and supports the following formats: DVD-RAM, DVD-RW, DVD+RW, DVD+R, DVD-R, DVD-ROM, DVD-R DL, CD-RW, CD-R, CD-ROM.

I/O expansion options

The ST45 V3 server has three PCIe 3.0 slots:

- Slot 1: PCIe 3.0 x16 (from CPU)(FHHL)(x16 slot, closed-ended) 75 W
- Slot 3: PCIe 3.0 x1 (from chipset PRO 665)(FHHL)(x1 slot, closed-ended) 25 W

The following figure shows the locations of the PCIe slots.

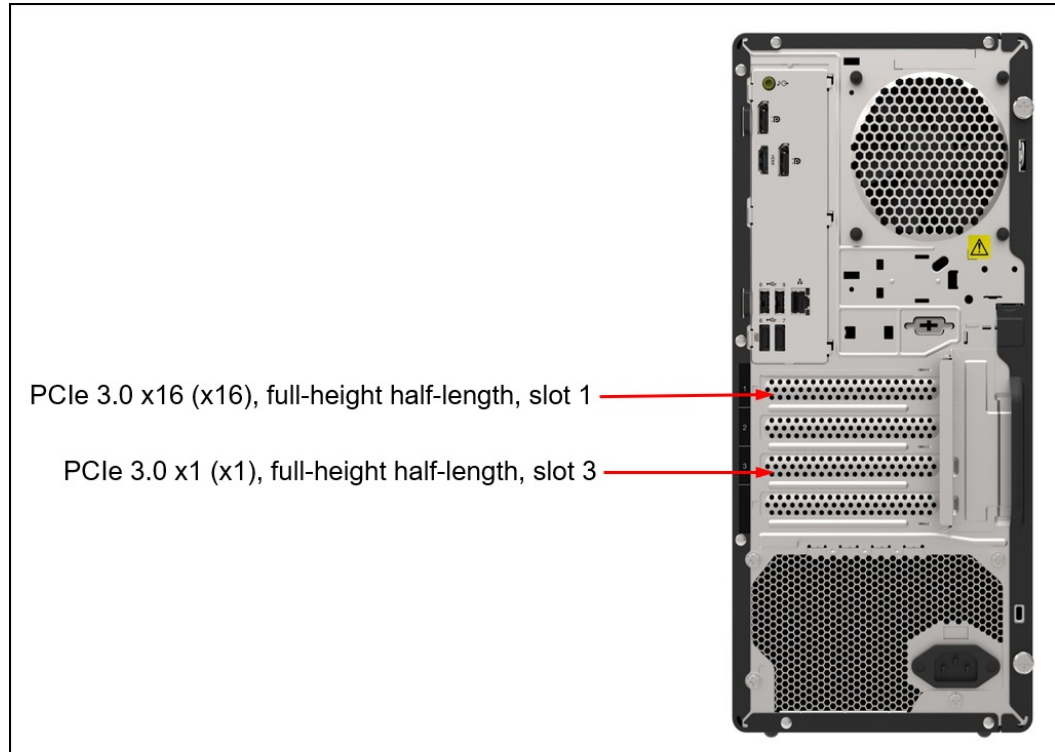

Figure 8. ThinkSystem ST45 V3 PCIe slots

Network adapters

The ST45 V3 server supports Realtek RTL8111FP onboard 1GbE ethernet, the RTL8111FP is compatible with the IEEE 802.3u specification for 10/100Mbps Ethernet and the IEEE 802.3ab specification for 1000Mbps Ethernet.

It also supports an auxiliary power auto-detect function, and will auto-configure related bits of the PCI power management registers in PCI configuration space.

The onboard NIC has the following features:

- Wake-On-LAN support
- Supports Magic Packet Wake-Up.
- Support Onboard IPV4 and IPV6 PXE boot (Preboot eXecution Environment).

Note: SR-IOV/Virtualization/iSCSI/RDMA features non-support (Controller Hardware) on ST45 V3.

The following table lists other supported network adapters. The maximum supported column indicates which slots each adapter is supported in. For slot locations see the [I/O expansion options](#) section.

Table 22. Network adapters

Part number	Feature code	Description	Slots supported	Maximum supported
Gigabit Ethernet				
7ZT7A00484	AUZV	ThinkSystem Broadcom 5719 1GbE RJ45 4-Port PCIe Ethernet Adapter	slot 1	1
10 Gb Ethernet				
7ZT7A00496	AUKP	ThinkSystem Broadcom 57416 10GBASE-T 2-Port PCIe Ethernet Adapter	slot 1	1

Configuration notes:

- For more information, including the transceivers and cables that each adapter supports, see the list of Lenovo Press Product Guides in the Ethernet adapters category: <https://lenovopress.com/servers/options/ethernet>

SAS adapters for external storage

The ST45 V3 currently does not support SAS adapters for external storage.

Fibre Channel host bus adapters

The ST45 V3 does not support Fibre Channel host bus adapters.

GPU adapters

The ST45 V3 server does not support graphics processing units (GPUs).

Cooling

The server supports the following fans:

- CPU heat sink fan
- Front side fan
- Rear side fan

The 4-wire fan connector fan has the following electrical input, monitoring and control connections:

- 12V DC Power
- DC Power Return
- Tachometer Output
- Pulse Width Modulation Control

See the Inside view in the [Components and connectors](#) section for locations.

Power supplies

The ST45 V3 server supports a single fixed (non-hot-swap) power supply. The power supply cannot be upgraded.

The server supports a single fixed power supply. The following table lists the supported power supplies.

Table 23. Power supplies

Part number	Feature code	Description	Maximum quantity	ErP Lot 9 compliant	110V AC	220V AC
Fixed power supplies						
CTO only	BMFL	ATX-300W Power Supply	1	No	Yes	Yes
CTO only	BMTC	ThinkSystem 500W Platinum ATX Power Supply	1	Yes	Yes	Yes

Power supply options do not include a line cord.

For server configurations, the inclusion of a power supply is model dependent. Configure-to-order models can be configured without a power cord if desired.

To ensure that the properly sized power supply is chosen for optimal performance, it is highly recommended to validate system configuration for specific power requirements by using the latest version of the Lenovo Capacity Planner:

<https://datacentersupport.lenovo.com/us/en/products/solutions-and-software/software/lenovo-capacity-planner/solutions/ht504651>

Power cords

Line cords and rack power cables with C13 connectors can be ordered as listed in the following table.

110V customers: If you plan to use the 1100W power supply with a 110V power source, select a power cable that is rated above 10A. Power cables that are rated at 10A or below are not supported with 110V power.

Table 24. Power cords

Part number	Feature code	Description
Rack cables - C13 to C14		
SL67B08593	BPHZ	0.5m, 10A/100-250V, C13 to C14 Jumper Cord
00Y3043	A4VP	1.0m, 10A/100-250V, C13 to C14 Jumper Cord
4L67A08367	B0N5	1.0m, 13A/100-250V, C13 to C14 Jumper Cord
39Y7937	6201	1.5m, 10A/100-250V, C13 to C14 Jumper Cord
4L67A08368	B0N6	1.5m, 13A/100-250V, C13 to C14 Jumper Cord
4L67A08365	B0N4	2.0m, 10A/100-250V, C13 to IEC 320-C14 Rack Power Cable
4L67A08369	6570	2.0m, 13A/100-250V, C13 to C14 Jumper Cord
4L67A08366	6311	2.8m, 10A/100-250V, C13 to C14 Jumper Cord
4L67A08370	6400	2.8m, 13A/100-250V, C13 to C14 Jumper Cord

Part number	Feature code	Description
39Y7932	6263	4.3m, 10A/100-250V, C13 to IEC 320-C14 Rack Power Cable
4L67A08371	6583	4.3m, 13A/100-250V, C13 to C14 Rack Power Cable
Rack cables - C13 to C14 (Y-cable)		
00Y3046	A4VQ	1.345m, 2X C13 to C14 Jumper Cord, Rack Power Cable
00Y3047	A4VR	2.054m, 2X C13 to C14 Jumper Cord, Rack Power Cable
Rack cables - C13 to C20		
39Y7938	6204	2.8m, 10A/100-250V, C13 to IEC 320-C20 Rack Power Cable
Rack cables - C13 to C20 (Y-cable)		
47C2491	A3SW	1.2m, 16A/100-250V, 2 Short C13s to Short C20 Rack Power Cable
47C2492	A3SX	2.5m, 16A/100-250V, 2 Long C13s to Short C20 Rack Power Cable
47C2493	A3SY	2.8m, 16A/100-250V, 2 Short C13s to Long C20 Rack Power Cable
47C2494	A3SZ	4.1m, 16A/100-250V, 2 Long C13s to Long C20 Rack Power Cable
Line cords		
39Y7930	6222	2.8m, 10A/250V, C13 to IRAM 2073 (Argentina) Line Cord
81Y2384	6492	4.3m 10A/220V, C13 to IRAM 2073 (Argentina) Line Cord
39Y7924	6211	2.8m, 10A/250V, C13 to AS/NZ 3112 (Australia/NZ) Line Cord
81Y2383	6574	4.3m, 10A/230V, C13 to AS/NZS 3112 (Aus/NZ) Line Cord
69Y1988	6532	2.8m, 10A/250V, C13 to NBR 14136 (Brazil) Line Cord
81Y2387	6404	4.3m, 10A/250V, C13 - 2P+Gnd (Brazil) Line Cord
39Y7928	6210	2.8m, 220-240V, C13 to GB 2099.1 (China) Line Cord
81Y2378	6580	4.3m, 10A/220V, C13 to GB 2099.1 (China) Line Cord
39Y7918	6213	2.8m, 10A/250V, C13 to DK2-5a (Denmark) Line Cord
81Y2382	6575	4.3m, 10A/230V, C13 to DK2-5a (Denmark) Line Cord
39Y7917	6212	2.8m, 10A/230V, C13 to CEE7-VII (Europe) Line Cord
81Y2376	6572	4.3m, 10A/230V, C13 to CEE7-VII (Europe) Line Cord
39Y7927	6269	2.8m, 10A/250V, C13(2P+Gnd) (India) Line Cord
81Y2386	6567	4.3m, 10A/240V, C13 to IS 6538 (India) Line Cord
39Y7920	6218	2.8m, 10A/250V, C13 to SI 32 (Israel) Line Cord
81Y2381	6579	4.3m, 10A/230V, C13 to SI 32 (Israel) Line Cord
39Y7921	6217	2.8m, 220-240V, C13 to CEI 23-16 (Italy/Chile) Line Cord
81Y2380	6493	4.3m, 10A/230V, C13 to CEI 23-16 (Italy/Chile) Line Cord
46M2593	A1RE	2.8m, 12A/125V, C13 to JIS C-8303 (Japan) Line Cord
4L67A08362	6495	4.3m, 12A/200V, C13 to JIS C-8303 (Japan) Line Cord
39Y7926	6335	4.3m, 12A/100V, C13 to JIS C-8303 (Japan) Line Cord
39Y7922	6214	2.8m, 10A/250V, C13 to SABS 164 (S Africa) Line Cord
81Y2379	6576	4.3m, 10A/230V, C13 to SABS 164 (South Africa) Line Cord
39Y7925	6219	2.8m, 220-240V, C13 to KETI (S Korea) Line Cord
81Y2385	6494	4.3m, 12A/220V, C13 to KSC 8305 (S. Korea) Line Cord
39Y7919	6216	2.8m, 10A/250V, C13 to SEV 1011-S24507 (Swiss) Line Cord
81Y2390	6578	4.3m, 10A/230V, C13 to SEV 1011-S24507 (Sws) Line Cord
23R7158	6386	2.8m, 10A/125V, C13 to CNS 10917-3 (Taiwan) Line Cord
81Y2375	6317	2.8m, 10A/240V, C13 to CNS 10917-3 (Taiwan) Line Cord
81Y2374	6402	2.8m, 13A/125V, C13 to CNS 60799 (Taiwan) Line Cord

Part number	Feature code	Description
4L67A08363	AX8B	4.3m, 10A 125V, C13 to CNS 10917 (Taiwan) Line Cord
81Y2389	6531	4.3m, 10A/250V, C13 to 76 CNS 10917-3 (Taiwan) Line Cord
81Y2388	6530	4.3m, 13A/125V, C13 to CNS 10917 (Taiwan) Line Cord
39Y7923	6215	2.8m, 10A/250V, C13 to BS 1363/A (UK) Line Cord
81Y2377	6577	4.3m, 10A/230V, C13 to BS 1363/A (UK) Line Cord
90Y3016	6313	2.8m, 10A/120V, C13 to NEMA 5-15P (US) Line Cord
46M2592	A1RF	2.8m, 10A/250V, C13 to NEMA 6-15P Line Cord
00WH545	6401	2.8m, 13A/120V, C13 to NEMA 5-15P (US) Line Cord
4L67A08359	6370	4.3m, 10A/125V, C13 to NEMA 5-15P (US) Line Cord
4L67A08361	6373	4.3m, 10A/250V, C13 to NEMA 6-15P (US) Line Cord
4L67A08360	AX8A	4.3m, 13A/120V, C13 to NEMA 5-15P (US) Line Cord

Systems management

ST45 V3 offers systems management using Lenovo XClarity Provisioning Manager Lite (LXPM Lite).

Note: The ST45 V3 server does not have an XClarity Controller (XCC) management processor

Lenovo XClarity Provisioning Manager Lite

Lenovo XClarity Provisioning Manager Lite (LXPM Lite) is a USB memory key-based application for system setup and firmware upgrades.

The software tool provides the following functions:

- Easy-to-use, language-selectable graphical interface
- Integrated help system
- Automatic hardware detection
- Ability to install an operating system and device drivers either in an unattended mode or manually
- Ability to clone the settings in one server to other similarly configured Lenovo servers
- Supports RAID setup
- Diagnostics for memory test, hard disk drive test, and RAID log collection.

The LXPM Lite user interface is shown in the following figure.

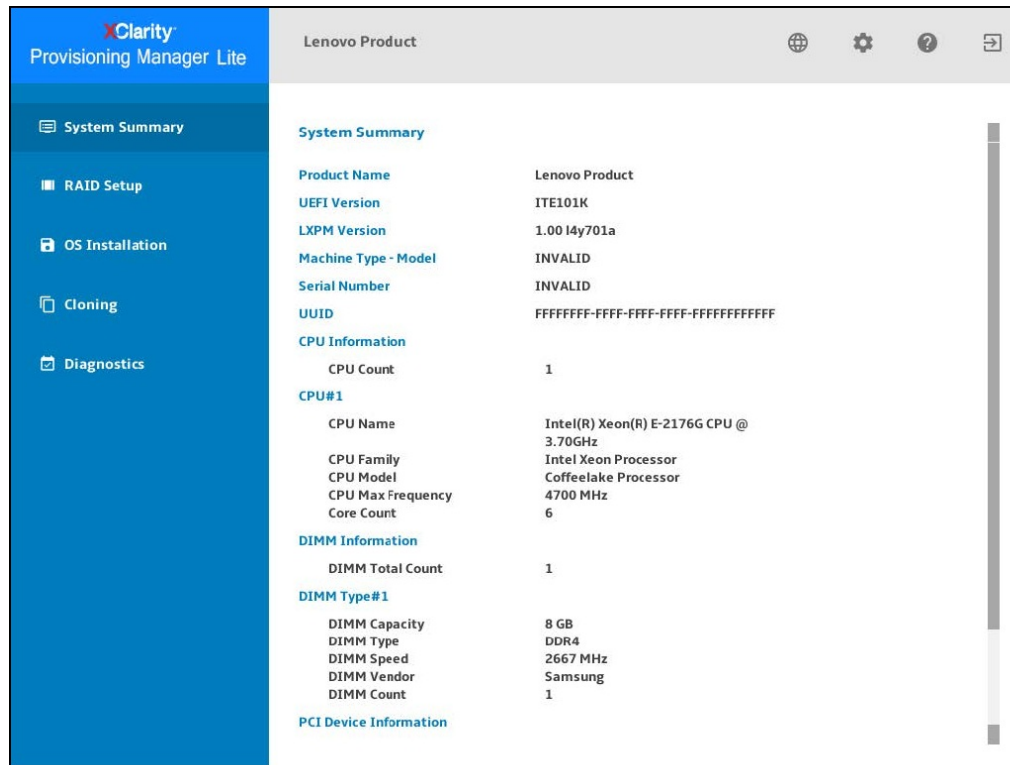

Figure 9. Lenovo XClarity Provisioning Manager Lite user interface

For more information about LXPM Lite, and to download the application, see the following support page: <https://datacentersupport.lenovo.com/us/en/solutions/HT507133>

Security

The ST45 V3 offers the following security features:

- Electronic security measures:
 - Administrator and power-on passwords
 - Trusted Platform Module (TPM) supporting TPM 2.0
- Mechanical security measures
 - Loop for a padlock to prevent the side panel from being opened
 - Slot at the rear of the server for a Kensington Cable Lock

The ST45 V3 is NIST 800-147 compliant

Keyboards and Mice

The following table lists the supported full-sized USB keyboards and mice available for Lenovo ThinkSystem servers.

The keyboards have the following features:

- Full-sized 104-key keyboard with 3 special Windows keys
- 3 LEDs for caps lock, scroll lock and num lock
- Wired USB connection with 1.8m cable
- Adjustable feet at the rear of the keyboard

Tip: For keyboards that fit in the rack-mounted console kit, see the [KVM console options](#) section, or the [ThinkSystem 18.5-inch LCD Console](#) product guide

Table 25. Lenovo Preferred Pro USB Full-sized keyboards - ThinkSystem

Part number	Feature code	Description
Mice		
7M57A04698	B0LN	ThinkSystem Optical Wheel Mouse - USB
Keyboards		
7ZB7A05521	AXTM	ThinkSystem Pref. Pro II USB Keyboard - Arabic
7ZB7A05520	AXTN	ThinkSystem Pref. Pro II USB Keyboard - Arabic/French
7ZB7A05519	AXTP	ThinkSystem Pref. Pro II USB Keyboard - Belgium/French
7ZB7A05518	AXTQ	ThinkSystem Pref. Pro II USB Keyboard - Belgium/UK
7ZB7A05517	AXTR	ThinkSystem Pref. Pro II USB Keyboard - Brazil/Portuguese
7ZB7A05515	AXTS	ThinkSystem Pref. Pro II USB Keyboard - Bulgarian
7ZB7A05511	AXTU	ThinkSystem Pref. Pro II USB Keyboard - Czech
7ZB7A05509	AXTV	ThinkSystem Pref. Pro II USB Keyboard - Danish
7ZB7A05508	AXTW	ThinkSystem Pref. Pro II USB Keyboard - Dutch
7ZB7A05506	AXTX	ThinkSystem Pref. Pro II USB Keyboard - French
7ZB7A05496	AXTZ	ThinkSystem Pref. Pro II USB Keyboard - French Canadian French
7ZB7A05504	AXTY	ThinkSystem Pref. Pro II USB Keyboard - French Canadian Multilingual
7ZB7A05495	AXU0	ThinkSystem Pref. Pro II USB Keyboard - German
7ZB7A05494	AXU1	ThinkSystem Pref. Pro II USB Keyboard - Greek
7ZB7A05493	AXU2	ThinkSystem Pref. Pro II USB Keyboard - Hebrew
7ZB7A05492	AXU3	ThinkSystem Pref. Pro II USB Keyboard - Hungarian
7ZB7A05491	AXU4	ThinkSystem Pref. Pro II USB Keyboard - Iceland
7ZB7A05490	AXU5	ThinkSystem Pref. Pro II USB Keyboard - Italy

Part number	Feature code	Description
7ZB7A05489	AXU6	ThinkSystem Pref. Pro II USB Keyboard -Japanese
7ZB7A05488	AXU7	ThinkSystem Pref. Pro II USB Keyboard - Korean
7ZB7A05487	AXU8	ThinkSystem Pref. Pro II USB Keyboard - LA Spanish
7ZB7A05486	AXU9	ThinkSystem Pref. Pro II USB Keyboard - Norwegian
7ZB7A05485	AXUA	ThinkSystem Pref. Pro II USB Keyboard - Polish
7ZB7A05484	AXUB	ThinkSystem Pref. Pro II USB Keyboard- Portugese
7ZB7A05483	AXUC	ThinkSystem Pref. Pro II USB Keyboard - Romanian
7ZB7A05482	AXUD	ThinkSystem Pref. Pro II USB Keyboard - Russian/Cy
7ZB7A05481	AXUE	ThinkSystem Pref. Pro II USB Keyboard - Serbian/Cyrilic
7ZB7A05480	AXUF	ThinkSystem Pref. Pro II USB Keyboard - Slovak
7ZB7A05471	AXUQ	ThinkSystem Pref. Pro II USB Keyboard - Slovenian
7ZB7A05479	AXUG	ThinkSystem Pref. Pro II USB Keyboard - Spanish
7ZB7A05478	AXUH	ThinkSystem Pref. Pro II USB Keyboard- Swedish/Finn
7ZB7A05477	AXUJ	ThinkSystem Pref. Pro II USB Keyboard - Swiss, F/G
7ZB7A05476	AXUK	ThinkSystem Pref. Pro II USB Keyboard - Thailand
7ZB7A05513	AXTT	ThinkSystem Pref. Pro II USB Keyboard - Trad Chinese/US
7ZB7A05474	AXUM	ThinkSystem Pref. Pro II USB Keyboard - Turkish 179
7ZB7A05475	AXUL	ThinkSystem Pref. Pro II USB Keyboard - Turkish 440
7ZB7A05473	AXUN	ThinkSystem Pref. Pro II USB Keyboard - UK English
7ZB7A05522	AXTL	ThinkSystem Pref. Pro II USB Keyboard - US English
7ZB7A05472	AXUP	ThinkSystem Pref. Pro II USB Keyboard - US Euro

Video port adapters

The ST45 V3 has two integrated DisplayPort video ports at the back of the server. To use these ports with VGA or HDMI cables, use the dongle adapters listed in the following table.

Tip: Some models include a dongle kit. See the [Models](#) section for specifics.

Table 26. Video port dongles

Part number	Feature code	Description	Maximum supported
4X97A12099	B365	ThinkSystem DP to VGA Dongle Kit	2
4X97A12100	B366	ThinkSystem DP to HDMI Dongle Kit	2

Maximum display resolutions are as follows:

- Native DisplayPort: 3840 x 2160 pixels (4K) at a refresh rate of 60Hz
- With the DP to VGA Dongle Kit: 1920 x 1200 pixels at 60 Hz
- With the DP to HDMI Dongle Kit: 1920 x 1200 pixels at 60 Hz

Configuration requirements:

- Only one type of dongle can be used at a time. The use of one of each is not supported.
- Some Xeon processors do not support integrated graphics and the use of the DisplayPort video ports. See the [Processors](#) section for details.

Operating system support

The ST45 V3 supports the following operating systems:

- Microsoft Windows Server 2022
- Red Hat Enterprise Linux 9.4
- SUSE Linux Enterprise Server 15 SP6
- Ubuntu 24.04 LTS 64-bit

For a complete list of supported, certified and tested operating systems, plus additional details and links to relevant web sites, see the Operating System Interoperability Guide: <https://lenovopress.com/osig>

Additional requirements

Additional requirements for operating systems:

- The ST45 V3 supports UEFI BIOS boot mode only; Legacy boot mode isn't supported.
- The ST45 V3 does not support ACPI S3 (Sleep) or ACPI S4 (Hibernate) modes when running Windows 10 or Windows 11.
- The onboard SATA ports of the server can be used with virtualization hypervisors, including Linux KVM, Xen, and Microsoft Hyper-V Server, however support is limited to AHCI (non-RAID) mode.
- The DisplayPort video ports require the following:
 - Linux: kernel/boot parameter "nomodeset" is added

Physical and electrical specifications

The ST45 V3 has the following overall physical dimensions, including tower feet, excluding components that extend outside the standard chassis, such as power supply handles:

- Width: 170 mm (6.7 inches)
- Height: 376 mm (14.8 inches) (Without Stand - 370 mm)
- Depth: 316 mm (12.4 inches)

The following table lists the detailed dimensions. See the figure below for the definition of each dimension.

Table 27. Detailed dimensions

Dimension	Description
170 mm	X_a = Width, using widest features (not including feet)
132 mm	X_b = Width, between the outer edges of the feet
376 mm	Y_a = Height, from bottom of feet to top of chassis body
370 mm	Y_b = Height, from bottom of chassis body to top of chassis body
299 mm	Z_a = Depth, from front door to most rearward I/O port surface
316 mm	Z_b = Depth, from front door to deepest feature of the chassis body feature
316 mm	Z_c = Depth, from front door to deepest feature such as power supply handle
37 mm	Z_e = Depth, front door to front plate of chassis body

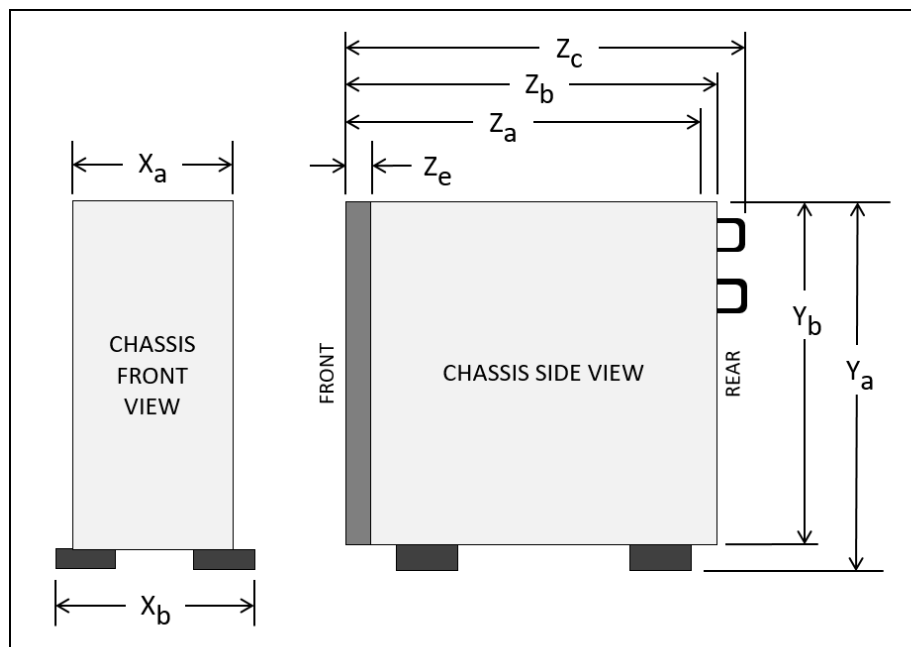

Figure 10. Server dimension

The shipping (cardboard packaging) dimensions of the ST45 V3 are as follows:

- Width: 280 mm (11.0 inches)
- Height: 540 mm (21.3 inches)
- Depth: 420 mm (16.5 inches)

The server has the following weight:

- Maximum: 8.56 kg (18.87 lb)

Electrical requirements are as follows:

- Fixed ATX 300-watt Single-Output Gold
 - Input power 115 Vac or 230 Vac
- Fixed ATX 500-watt Multi-Output Platinum
 - Input power 115 Vac or 230 Vac

Operating environment

The ST45 V3 server complies with ASHRAE Class A2 specifications.

Temperature and humidity

The server is supported in the following environment:

- Air temperature:
 - Operating:
 - ASHRAE Class A2: 10°C to 35°C (50°F to 95°F); the maximum ambient temperature decreases by 1°C for every 300 m (984 ft) increase in altitude above 900 m (2,953 ft).
 - Server off: 5°C to 45°C (41°F to 113°F)
 - Shipment/storage: -20°C to 60°C (-4°F to 140°F)
- Maximum altitude: 3,050 m (10,000 ft), derated 1°C per 300 m above 950 m
- Relative Humidity (non-condensing):
 - Operating
 - ASHRAE Class A2: 8% to 80%; maximum dew point: 21°C (70°F)
 - Shipment/storage: 8% to 90%

Acoustic noise emissions

The server has the following acoustic noise emissions declaration:

- Sound power level ($L_{WA,d}$):
 - Idling: Typical: 3.5 Bel, Maximum: 5.0 Bel
 - Operating: Typical: 5.4 Bel, Maximum: 5.4 Bel
- Sound pressure level (L_{pAm}):
 - Idling: Typical: 25 dBA, Maximum: 37 dBA
 - Operating: Typical: 40 dBA, Maximum: 40 dBA

Note:

- These sound levels were measured in controlled acoustical environments according to procedures specified by ISO 7779 and are reported in accordance with ISO 9296.
- The declared acoustic sound levels are based on the following configurations, which may change depending on configuration/conditions:
 - Typical: 1x 80W CPU, 4x 32GB DIMM, 2x HDD or SSD, 1x 960G M.2, RAID 5350-8i, 1x 300W PSU
 - Maximum: 1x 95W CPU, 4x 32GB DIMM, 2x HDD or SSD, 1x 960G M.2, 1x T1000GPU, 1x 500W PSU

Heat output

The server generates the following heat:

- Heat/thermal output:
 - Minimum configuration: 443 BTU/hr, 130 W
 - Maximum configuration: 754 BTU/hr, 221 W

Shock and vibration

The server has the following vibration and shock limits:

- Vibration:
 - Operating: 0.21 G rms at 5 Hz to 500 Hz for 15 minutes across 3 axes
 - Non-operating: 1.04 G rms at 2 Hz to 200 Hz for 15 minutes across 6 surfaces
- Shock:
 - Operating: 15 G for 3 milliseconds in each direction (positive and negative X, Y, and Z axes)
 - Non-operating:
 - 4 kg - 11 kg: 50 G for 167 in./sec velocity change across 6 surfaces

Particulate contamination

Airborne particulates (including metal flakes or particles) and reactive gases acting alone or in combination with other environmental factors such as humidity or temperature might damage the system that might cause the system to malfunction or stop working altogether.

The following specifications indicate the limits of particulates that the system can tolerate:

- Reactive gases:
 - The copper reactivity level shall be less than 200 Angstroms per month (Å/month)
 - The silver reactivity level shall be less than 200 Å/month
- Airborne particulates:
 - The room air should be continuously filtered with MERV 8 filters.
 - Air entering a data center should be filtered with MERV 11 or preferably MERV 13 filters.
 - The deliquescent relative humidity of the particulate contamination should be more than 60% RH
 - Environment must be free of zinc whiskers

For additional information, see the Specifications section of the documentation for the server, available from the Lenovo Documents site, <https://pubs.lenovo.com/>

Warranty upgrades and post-warranty support

The ST45 V3 has a 1-year or 3-year warranty, based on the machine type of the system:

- 7DH4 - 1 year warranty
- 7DH5 - 3 year warranty

Our global network of regional support centers offers consistent, local-language support enabling you to vary response times and level of service to match the criticality of your support needs:

- **Standard Next Business Day** – Best choice for non-essential systems requiring simple maintenance.
- **Premier Next Business Day** – Best choice for essential systems requiring technical expertise from senior-level Lenovo engineers.
- **Premier 24x7 4-Hour Response** – Best choice for systems where maximum uptime is critical.
- **Premier Enhanced Storage Support 24x7 4-Hour Response** – Best choice for storage systems where maximum uptime is critical.

For more information, consult the brochure [Lenovo Operational Support Services for Data Centers Services](#).

Services

Lenovo Data Center Services empower you at every stage of your IT lifecycle. From expert advisory and strategic planning to seamless deployment and ongoing support, we ensure your infrastructure is built for success. Our comprehensive services accelerate time to value, minimize downtime, and free your IT staff to focus on driving innovation and business growth.

Note: Some service options may not be available in all markets or regions. For more information, go to <https://lenovocator.com/>. For information about Lenovo service upgrade offerings that are available in your region, contact your local Lenovo sales representative or business partner.

In this section:

- [Lenovo Advisory Services](#)
- [Lenovo Plan & Design Services](#)
- [Lenovo Deployment, Migration, and Configuration Services](#)
- [Lenovo Support Services](#)
- [Lenovo Managed Services](#)
- [Lenovo Sustainability Services](#)

Lenovo Advisory Services

Lenovo Advisory Services simplify the planning process, enabling customers to build future-proofed strategies in as little as six weeks. Consultants provide guidance on projects including VM migration, storage, backup and recovery, and cost management to accelerate time to value, improve cost efficiency, and build a flexibly scalable foundation.

- **Assessment Services**

An Assessment helps solve your IT challenges through an onsite, multi-day session with a Lenovo technology expert. We perform a tools-based assessment which provides a comprehensive and thorough review of a company's environment and technology systems. In addition to the technology based functional requirements, the consultant also discusses and records the non-functional business requirements, challenges, and constraints. Assessments help organizations like yours, no matter how large or small, get a better return on your IT investment and overcome challenges in the ever-changing technology landscape.

- **Design Services**

Professional Services consultants perform infrastructure design and implementation planning to support your strategy. The high-level architectures provided by the assessment service are turned into low level designs and wiring diagrams, which are reviewed and approved prior to implementation. The implementation plan will demonstrate an outcome-based proposal to provide business capabilities through infrastructure with a risk-mitigated project plan.

Lenovo Plan & Design Services

Unlock faster time to market with our tailored, strategic design workshops to align solution approaches with your business goals and technical requirements. Leverage our deep solution expertise and end-to-end delivery partnership to meet your goals efficiently and effectively.

Lenovo Deployment, Migration, and Configuration Services

Optimize your IT operations by shifting labor-intensive functions to Lenovo's skilled technicians for seamless on-site or remote deployment, configuration, and migration. Enjoy peace of mind, faster time to value, and comprehensive knowledge sharing with your IT staff, backed by our best-practice methodology.

- **Deployment Services for Storage and ThinkAgile**

A comprehensive range of remote and onsite options tailored specifically for your business needs to ensure your storage and ThinkAgile hardware are fully operational from the start.

- **Hardware Installation Services**

A full-range, comprehensive setup for your hardware, including unpacking, inspecting, and positioning components to ensure your equipment is operational and error-free for the most seamless and efficient installation experience, so you can quickly benefit from your investments.

- **DM/DG File Migration Services**

Take the burden of file migration from your IT's shoulders. Our experts will align your requirements and business objectives to the migration plans while coordinating with your team to plan and safely execute the data migration to your storage platforms.

- **DM/DG/DE Health Check Services**

Our experts perform proactive checks of your Firmware and system health to ensure your machines are operating at peak and optimal efficiency to maximize up-time, avoid system failures, ensure the security of IT solutions and simplify maintenance.

- **Factory Integrated Services**

A suite of value-added offerings provided during the manufacturing phase of a server or storage system that reduces time to value. These services aim at improving your hardware deployment experience and enhance the quality of a standard configuration before it arrives at your facility.

Lenovo Support Services

In addition to response time options for hardware parts, repairs, and labor, Lenovo offers a wide array of additional support services to ensure your business is positioned for success and longevity. Our goal is to reduce your capital outlays, mitigate your IT risks, and accelerate your time to productivity.

- **Premier Support for Data Centers**

Your direct line to the solution that promises the best, most comprehensive level of support to help you fully unlock the potential of your data center.

- **Premier Enhanced Storage Support (PESS)**

Gain all the benefits of Premier Support for Data Centers, adding dedicated storage specialists and resources to elevate your storage support experience to the next level.

- **Committed Service Repair (CSR)**

Our commitment to ensuring the fastest, most seamless resolution times for mission-critical systems that require immediate attention to ensure minimal downtime and risk for your business. This service is only available for machines under the Premier 4-Hour Response SLA.

- **Multivendor Support Services (MVS)**

Your single point of accountability for resolution support across vast range of leading Server, Storage, and Networking OEMs, allowing you to manage all your supported infrastructure devices seamlessly from a single source.

- **Keep Your Drive (KYD)**

Protect sensitive data and maintain compliance with corporate retention and disposal policies to ensure your data is always under your control, regardless of the number of drives that are installed in your Lenovo server.

- **Technical Account Manager (TAM)**

Your single point of contact to expedite service requests, provide status updates, and furnish reports to track incidents over time, ensuring smooth operations and optimized performance as your business grows.

- **Enterprise Software Support (ESS)**

Gain comprehensive, single-source, and global support for a wide range of server operating systems and Microsoft server applications.

For more information, consult the brochure [Lenovo Operational Support Services for Data Centers](#).

Lenovo Managed Services

Achieve peak efficiency, high security, and minimal disruption with Lenovo's always-on Managed Services. Our real-time monitoring, 24x7 incident response, and problem resolution ensure your infrastructure operates seamlessly. With quarterly health checks for ongoing optimization and innovation, Lenovo's remote active monitoring boosts end-user experience and productivity by keeping your data center's hardware performing at its best.

Lenovo Managed Services provides continuous 24x7 remote monitoring (plus 24x7 call center availability) and proactive management of your data center using state-of-the-art tools, systems, and practices by a team of highly skilled and experienced Lenovo services professionals.

Quarterly reviews check error logs, verify firmware & OS device driver levels, and software as needed. We'll also maintain records of latest patches, critical updates, and firmware levels, to ensure your systems are providing business value through optimized performance.

Lenovo Sustainability Services

- **Asset Recovery Services**

Lenovo Asset Recovery Services (ARS) provides a secure, seamless solution for managing end-of-life IT assets, ensuring data is safely sanitized while contributing to a more circular IT lifecycle. By maximizing the reuse or responsible recycling of devices, ARS helps businesses meet sustainability goals while recovering potential value from their retired equipment. For more information, see the [Asset Recovery Services offering page](#).

- **CO2 Offset Services**

Lenovo's CO2 Offset Services offer a simple and transparent way for businesses to take tangible action on their IT footprint. By integrating CO2 offsets directly into device purchases, customers can easily support verified climate projects and track their contributions, making meaningful progress toward their sustainability goals without added complexity.

- **Lenovo Certified Refurbished**

Lenovo Certified Refurbished offers a cost-effective way to support IT circularity without compromising on quality and performance. Each device undergoes rigorous testing and certification, ensuring reliable performance and extending its lifecycle. With Lenovo's trusted certification, you gain peace of mind while making a more sustainable IT choice.

Lenovo TruScale

Lenovo TruScale XaaS is your set of flexible IT services that makes everything easier. Streamline IT procurement, simplify infrastructure and device management, and pay only for what you use – so your business is free to grow and go anywhere.

Lenovo TruScale is the unified solution that gives you simplified access to:

- The industry's broadest portfolio – from pocket to cloud – all delivered as a service
- A single-contract framework for full visibility and accountability
- The global scale to rapidly and securely build teams from anywhere
- Flexible fixed and metered pay-as-you-go models with minimal upfront cost
- The growth-driving combination of hardware, software, infrastructure, and solutions – all from one single provider with one point of accountability.

For information about Lenovo TruScale offerings that are available in your region, contact your local Lenovo sales representative or business partner.

Regulatory compliance

The ST45 V3 conforms to the following standards:

- ANSI/UL 62368-1
- IEC 62368-1 (CB Certificate and CB Test Report)
- CSA C22.2 No. 62368-1
- Argentina IEC 60950-1
- Mexico NOM-019
- India BIS 13252 (Part 1)
- Germany GS
- TUV-GS (EN62368-1, and EK1-ITB2000)
- Brazil INMETRO
- Ukraine UkrCEPRO
- Morocco CMIM Certification (CM)
- Russia, Belorussia and Kazakhstan, EAC: TP TC 004/2011 (for Safety); TP TC 020/2011 (for EMC)
- UL Green Guard, UL2819
- [Energy Star 4.0](#)
- EPEAT (NSF/ ANSI 426) Bronze
- Japanese Energy-Saving Act
- EU2019/424 Energy Related Product (ErP Lot9)
- China CCC certificate, GB17625.1; GB4943.1; GB/T9254
- China CECP certificate, CQC3135
- China CELP certificate, HJ 2507-2011

Uninterruptible power supply units

The following table lists the uninterruptible power supply (UPS) units that are offered by Lenovo.

Table 28. Uninterruptible power supply units

Part number	Description
Tower UPS units - 100-125VAC	
7DD6A000WW	T1kVA Tower UPS-G2 (100-125VAC)
7DD6A002WW	T1.5kVA Tower UPS-G2 (100-125VAC)
Tower UPS units - 200-240VAC	
7DD6A001WW	T1kVA Tower UPS-G2 (200-240VAC)
7DD6A003WW	T1.5kVA Tower UPS-G2 (200-240VAC)
Rack-mounted or tower UPS units - 100-125VAC	
7DD5A001WW	RT1.5kVA 2U Rack or Tower UPS-G2 (100-125VAC)
7DD5A003WW	RT3kVA 2U Rack or Tower UPS-G2 (100-125VAC)
Rack-mounted or tower UPS units - 200-240VAC	
7DD5A002WW	RT1.5kVA 2U Rack or Tower UPS-G2 (200-240VAC)
7DD5A005WW	RT3kVA 2U Rack or Tower UPS-G2 (200-240VAC)
7DD5A007WW	RT5kVA 3U Rack or Tower UPS-G2 (200-240VAC)
7DD5A008WW	RT6kVA 3U Rack or Tower UPS-G2 (200-240VAC)
7DD5A00AWW	RT11kVA 6U Rack or Tower UPS-G2 (200-240VAC)

† Only available in China and the Asia Pacific market.

For more information, see the list of Product Guides in the UPS category:

<https://lenovopress.com/servers/options/ups>

Power distribution units

The following table lists the power distribution units (PDUs) that are offered by Lenovo.

Table 29. Power distribution units

Part number	Feature code	Description	ANZ	ASEAN	Brazil	EET	MEA	RUCIS	WE	HTK	INDIA	JAPAN	LA	NA	PRC
0U Basic PDUs															
4PU7A93176	C0QH	0U 36 C13 and 6 C19 Basic 32A 1 Phase PDU v2	Y	Y	Y	Y	Y	Y	Y	Y	Y	N	Y	Y	Y
4PU7A93169	C0DA	0U 36 C13 and 6 C19 Basic 32A 1 Phase PDU	Y	Y	Y	Y	Y	Y	Y	Y	Y	N	Y	Y	Y
4PU7A93177	C0QJ	0U 24 C13/C15 and 24 C13/C15/C19 Basic 32A 3 Phase WYE PDU v2	Y	Y	Y	Y	Y	Y	Y	Y	Y	Y	Y	Y	Y
4PU7A93170	C0D9	0U 24 C13/C15 and 24 C13/C15/C19 Basic 32A 3 Phase WYE PDU	Y	Y	Y	Y	Y	Y	Y	Y	Y	N	Y	Y	Y
0U Switched and Monitored PDUs															
4PU7A93181	C0QN	0U 21 C13/C15 and 21 C13/C15/C19 Switched and Monitored 48A 3 Phase Delta PDU V2 (60A derated)	N	Y	N	N	N	N	N	Y	N	Y	N	Y	N
4PU7A93174	C0D5	0U 21 C13/C15 and 21 C13/C15/C19 Switched and Monitored 48A 3 Phase Delta PDU (60A derated)	N	Y	N	Y	N	N	Y	Y	N	N	N	Y	N
4PU7A93178	C0QK	0U 20 C13 and 4 C19 Switched and Monitored 32A 1 Phase PDU v2	Y	Y	Y	Y	Y	Y	Y	Y	Y	N	Y	Y	Y
4PU7A93171	C0D8	0U 20 C13 and 4 C19 Switched and Monitored 32A 1 Phase PDU	Y	Y	Y	Y	Y	Y	Y	Y	Y	N	Y	Y	Y
4PU7A93182	C0QP	0U 18 C13/C15 and 18 C13/C15/C19 Switched and Monitored 63A 3 Phase WYE PDU v2	Y	Y	Y	Y	Y	Y	Y	Y	Y	Y	Y	Y	Y
4PU7A93175	C0CS	0U 18 C13/C15 and 18 C13/C15/C19 Switched and Monitored 63A 3 Phase WYE PDU	Y	Y	Y	Y	Y	Y	Y	Y	Y	N	Y	Y	Y
4PU7A93180	C0QM	0U 18 C13/C15 and 18 C13/C15/C19 Switched and Monitored 32A 3 Phase WYE PDU v2	Y	Y	Y	Y	Y	Y	Y	Y	Y	Y	Y	Y	Y
4PU7A93173	C0D6	0U 18 C13/C15 and 18 C13/C15/C19 Switched and Monitored 32A 3 Phase WYE PDU	Y	Y	Y	Y	Y	Y	Y	Y	Y	N	Y	Y	Y
4PU7A93179	C0QL	0U 16 C13/C15 and 16 C13/C15/C19 Switched and Monitored 24A 1 Phase PDU v2 (30A derated)	N	Y	N	N	N	N	N	Y	N	Y	N	Y	N
4PU7A93172	C0D7	0U 16 C13/C15 and 16 C13/C15/C19 Switched and Monitored 24A 1 Phase PDU(30A derated)	N	Y	N	Y	N	N	Y	Y	N	N	N	Y	N
1U Switched and Monitored PDUs															
4PU7A90808	C0D4	1U 18 C19/C13 Switched and monitored 48A 3P WYE PDU V2 ETL	Y	Y	Y	Y	Y	Y	Y	Y	Y	Y	Y	Y	Y
4PU7A81117	BNDV	1U 18 C19/C13 switched and monitored 48A 3P WYE PDU - ETL	N	N	N	N	N	N	N	N	N	N	N	Y	N
4PU7A90809	C0DE	1U 18 C19/C13 Switched and monitored 48A 3P WYE PDU V2 CE	N	N	N	N	N	Y	Y	N	N	N	N	N	N
4PU7A81118	BNDW	1U 18 C19/C13 switched and monitored 48A 3P WYE PDU - CE	Y	Y	Y	Y	Y	Y	Y	Y	Y	N	Y	N	Y
4PU7A90810	C0DD	1U 18 C19/C13 Switched and monitored 80A 3P Delta PDU V2	Y	Y	Y	Y	Y	Y	Y	Y	Y	Y	Y	Y	Y

Part number	Feature code	Description	ANZ	ASEAN	Brazil	EET	MEA	RUCIS	WE	HTK	INDIA	JAPAN	LA	NA	PRC
4PU7A77467	BLC4	1U 18 C19/C13 Switched and Monitored 80A 3P Delta PDU	N	N	N	N	N	N	N	N	N	Y	N	Y	N
4PU7A90811	C0DC	1U 12 C19/C13 Switched and monitored 32A 3P WYE PDU V2	N	N	N	N	N	Y	Y	N	N	N	N	N	N
4PU7A77468	BLC5	1U 12 C19/C13 switched and monitored 32A 3P WYE PDU	Y	Y	Y	Y	Y	Y	Y	Y	Y	Y	Y	Y	Y
4PU7A90812	C0DB	1U 12 C19/C13 Switched and monitored 60A 3P Delta PDU V2	N	N	N	N	N	N	N	N	N	Y	N	N	N
4PU7A77469	BLC6	1U 12 C19/C13 switched and monitored 60A 3P Delta PDU	N	N	N	N	N	N	N	N	N	N	N	Y	N
1U Ultra Density Enterprise PDUs (9x IEC 320 C13 + 3x IEC 320 C19 outlets)															
71763NU	6051	Ultra Density Enterprise C19/C13 PDU 60A/208V/3PH	N	N	Y	N	N	N	N	N	N	Y	Y	Y	N
71762NX	6091	Ultra Density Enterprise C19/C13 PDU Module	Y	Y	Y	Y	Y	Y	Y	Y	Y	Y	Y	Y	Y
1U C13 Enterprise PDUs (12x IEC 320 C13 outlets)															
39Y8941	6010	DPI C13 Enterprise PDU Module (WW)	Y	Y	Y	Y	Y	Y	Y	Y	Y	Y	Y	Y	Y
1U Front-end PDUs (3x IEC 320 C19 outlets)															
39Y8938	6002	DPI Single-phase 30A/120V Front-end PDU (US)	Y	Y	Y	Y	Y	Y	Y	Y	Y	Y	Y	Y	Y
39Y8939	6003	DPI Single-phase 30A/208V Front-end PDU (US)	Y	Y	Y	Y	Y	Y	Y	Y	Y	Y	Y	Y	Y
39Y8934	6005	DPI Single-phase 32A/230V Front-end PDU (International)	Y	Y	Y	Y	Y	Y	Y	Y	Y	Y	Y	Y	Y
39Y8940	6004	DPI Single-phase 60A/208V Front-end PDU (US)	Y	N	Y	Y	Y	Y	Y	N	N	Y	Y	Y	N
39Y8935	6006	DPI Single-phase 63A/230V Front-end PDU (International)	Y	Y	Y	Y	Y	Y	Y	Y	Y	Y	Y	Y	Y
1U NEMA PDUs (6x NEMA 5-15R outlets)															
39Y8905	5900	DPI 100-127V NEMA PDU	Y	Y	Y	Y	Y	Y	Y	Y	Y	Y	Y	Y	Y
Line cords for 1U PDUs that ship without a line cord															
40K9611	6504	4.3m, 32A/380-415V, EPDU/IEC 309 3P+N+G 3ph wye (non-US) Line Cord	Y	Y	Y	Y	Y	Y	Y	Y	Y	Y	Y	Y	Y
40K9612	6502	4.3m, 32A/230V, EPDU to IEC 309 P+N+G (non-US) Line Cord	Y	Y	Y	Y	Y	Y	Y	Y	Y	Y	Y	Y	Y
40K9613	6503	4.3m, 63A/230V, EPDU to IEC 309 P+N+G (non-US) Line Cord	Y	Y	Y	Y	Y	Y	Y	Y	Y	Y	Y	Y	Y
40K9614	6500	4.3m, 30A/208V, EPDU to NEMA L6-30P (US) Line Cord	Y	Y	Y	Y	Y	Y	Y	Y	Y	Y	Y	Y	Y
40K9615	6501	4.3m, 60A/208V, EPDU to IEC 309 2P+G (US) Line Cord	N	N	Y	N	N	N	Y	N	N	Y	Y	Y	N
40K9617	6505	4.3m, 32A/230V, Souriau UTG Female to AS/NZ 3112 (Aus/NZ) Line Cord	Y	Y	Y	Y	Y	Y	Y	Y	Y	Y	Y	Y	Y
40K9618	6506	4.3m, 32A/250V, Souriau UTG Female to KSC 8305 (S. Korea) Line Cord	Y	Y	Y	Y	Y	Y	Y	Y	Y	Y	Y	Y	Y

For more information, see the Lenovo Press documents in the PDU category:
<https://lenovopress.com/servers/options/pdu>

KVM console options

The following table lists the supported KVM consoles.

Table 30. KVM console

Part number	Description
4XF7A84188	ThinkSystem 18.5" LCD Console (with US English keyboard)

The following table lists the available KVM switches and the options that are supported with them.

Table 32. KVM switches and options

Part number	Description
KVM Console switches	
1754D1X	Global 2x2x16 Console Manager (GCM16)
1754A2X	Local 2x16 Console Manager (LCM16)
1754A1X	Local 1x8 Console Manager (LCM8)
Cables for GCM and LCM Console switches	
46M5383	Virtual Media Conversion Option Gen2 (VCO2)
46M5382	Serial Conversion Option (SCO)

For more information, see the list of Product Guides in the KVM Switches and Consoles category:

<http://lenovopress.com/servers/options/kvm>

Lenovo Financial Services

Why wait to obtain the technology you need now? No payments for 90 days and predictable, low monthly payments make it easy to budget for your Lenovo solution.

- **Flexible**

Our in-depth knowledge of the products, services and various market segments allows us to offer greater flexibility in structures, documentation and end of lease options.

- **100% Solution Financing**

Financing your entire solution including hardware, software, and services, ensures more predictability in your project planning with fixed, manageable payments and low monthly payments.

- **Device as a Service (DaaS)**

Leverage latest technology to advance your business. Customized solutions aligned to your needs. Flexibility to add equipment to support growth. Protect your technology with Lenovo's Premier Support service.

- **24/7 Asset management**

Manage your financed solutions with electronic access to your lease documents, payment histories, invoices and asset information.

- **Fair Market Value (FMV) and \$1 Purchase Option Leases**

Maximize your purchasing power with our lowest cost option. An FMV lease offers lower monthly payments than loans or lease-to-own financing. Think of an FMV lease as a rental. You have the flexibility at the end of the lease term to return the equipment, continue leasing it, or purchase it for the fair market value. In a \$1 Out Purchase Option lease, you own the equipment. It is a good option when you are confident you will use the equipment for an extended period beyond the finance term. Both lease types have merits depending on your needs. We can help you determine which option will best meet your technological and budgetary goals.

Ask your Lenovo Financial Services representative about this promotion and how to submit a credit application. For the majority of credit applicants, we have enough information to deliver an instant decision and send a notification within minutes.

Seller training courses

The following sales training courses are offered for employees and partners (login required). Courses are listed in date order.

1. **ThinkSystem Rack and Tower Introduction for ISO Client Managers**

2024-12-10 | 20 minutes | Employees Only

In this course, you will learn about Lenovo's Data Center Portfolio, its ThinkSystem Family and the key features of the Rack and Tower servers. It will equip you with foundational knowledge which you can then expand upon by participating in the facilitated session of the curriculum.

Course Objectives:

- By the end of this course, you should be able to:
- Identify Lenovo's main data center brands.
- Describe the key components of the ThinkSystem Family servers.
- Differentiate between the Rack and Tower servers of the ThinkSystem Family.
- Understand the value Rack and Tower servers can provide to customers.

Published: 2024-12-10

Length: 20 minutes

Start the training:

Employee link: Grow@Lenovo

Course code: DSRT0101r2

2. **Lenovo Data Center Technical Sales Certification Exam Study Guide**

2024-11-27 | 10 minutes | Employees and Partners

This guide includes information to help candidates prepare and register for the Data Center Technical Sales practice and certification exams.

Published: 2024-11-27

Length: 10 minutes

Start the training:

Employee link: Grow@Lenovo

Partner link: [Lenovo Partner Learning](#)

Course code: LENU-322C-SG

3. **Lenovo Data Center Sales Certification Exam Study Guide**

2024-11-27 | 10 minutes | Employees and Partners

This guide includes information to help candidates prepare and register for the Data Center Sales practice and certification exams.

Published: 2024-11-27

Length: 10 minutes

Start the training:

Employee link: Grow@Lenovo

Partner link: [Lenovo Partner Learning](#)

Course code: LENU-122C-SG

4. **Partner Technical Webinar - Server Update with Mark Bica**

2024-11-26 | 60 minutes | Employees and Partners

In this 60-minute replay, Mark Bica, Lenovo Product Manager gave an update on the server portfolio. Mark presented on the new V4 Intel servers with Xeon 6 CPUs. He reviewed where the new AMD 5th Gen EPYC CPUs will be used in our servers. He followed with a review of the GPU dense servers including SR680, SR680a, SR575 and SR780a. Mark concluded with a review of the SC777 and SC750 that were introduced at TechWorld.

Published: 2024-11-26

Length: 60 minutes

Start the training:

Employee link: Grow@Lenovo

Partner link: [Lenovo Partner Learning](#)

Course code: 112224

5. **Family Portfolio: ThinkSystem Rackmount and Tower Servers powered by AMD**

2024-11-25 | 30 minutes | Employees and Partners

This course presents the key products and features of the ThinkSystem Rackmount and Tower server family powered by AMD processors. It describes customer benefits and will help you recognize when a specific product should be selected.

Course Objectives:

By the end of this course, you should be able to:

- Identify products and features within the family
- Describe customer benefits offered by this family
- Recognize when a specific product should be selected

Published: 2024-11-25

Length: 30 minutes

Start the training:

Employee link: Grow@Lenovo

Partner link: [Lenovo Partner Learning](#)

Course code: SXXW1216r10

6. **Q3 Solutions Launch AMD Powered ST45 V3 Quick Hit**

2024-11-25 | 3 minutes | Employees and Partners

The Lenovo ThinkSystem ST45 V3, the first Lenovo tower server with an AMD processor, is a compact-sized and affordable single-socket entry tower design optimized for SOHO (Small Office/Home Office), educational institutions, and retail offices. Target roles include file server, mail server, print server, FTP server, business application server and near-side data backup server.

Published: 2024-11-25

Length: 3 minutes

Start the training:

Employee link: Grow@Lenovo

Partner link: [Lenovo Partner Learning](#)

Course code: SXXW1216r10a

7. **Partner Technical Webinar - LenovoPress updates and LPH Demo**
2024-11-13 | 60 minutes | Employees and Partners

In this 60-minute replay, we had 3 topics. First, David Watts, Lenovo Sr Manager LenovoPress, gave an update on LenovoPress and improvements to finding Seller Training Courses (both partner and Lenovo). Next, Ryan Tuttle, Lenovo LETS Solution Architect, gave a demo of Lenovo Partner Hub (LPH) including how to find replays of Partner Webinars in LPL. Finally, Joe Murphy, Lenovo Sr Manager of LETS NA, gave a quick update on the new Stackable Warranty Options in DCSC.

Published: 2024-11-13
Length: 60 minutes

Start the training:
Employee link: [Grow@Lenovo](#)
Partner link: [Lenovo Partner Learning](#)

Course code: 110824

8. **Virtual Facilitated Session - ThinkSystem Rack and Tower Primer for ISO Client Managers**
2024-10-31 | 90 minutes | Employees Only

In this instructor-led Virtual Facilitated Session, ISO Client Managers will be able to build on the knowledge gained in Module 1 (eLearning) of the ThinkSystem Rack and Tower Server Primer for ISO Client Managers curriculum.

You will receive the invite to this session via email. Places are subject to availability.

IMPORTANT! Module 1 (eLearning) must be completed to be eligible to participate in the session.

Published: 2024-10-31
Length: 90 minutes

Start the training:
Employee link: [Grow@Lenovo](#)

Course code: DSRT0102

9. **Partner Technical Webinar - OneIQ**
2024-07-15 | 60 minutes | Employees and Partners

In this 60-minute replay, Peter Grant, Field CTO for OneIQ, reviewed and demo'd the capabilities of OneIQ including collecting data and analyzing. Additionally, Peter and the team discussed how specific partners (those with NA Channel SA coverage) will get direct access to OneIQ and other partners can get access to OneIQ via Distribution or the NA LETS team.

Published: 2024-07-15
Length: 60 minutes

Start the training:
Employee link: [Grow@Lenovo](#)
Partner link: [Lenovo Partner Learning](#)

Course code: 071224

10. **SAP Webinar for Lenovo Sellers: Lenovo Portfolio Update for SAP Landscapes**

2024-06-04 | 60 minutes | Employees Only

Join Mark Kelly, Advisory IT Architect with the Lenovo Global SAP Center of Competence as he discusses:

- Challenges in the SAP environment
- Lenovo On-premise Solutions for SAP
- Lenovo support resources for SAP solutions

Published: 2024-06-04

Length: 60 minutes

Start the training:

Employee link: Grow@Lenovo

Course code: DSAPF101

11. **Lenovo Data Center Product Portfolio**

2024-05-29 | 20 minutes | Employees and Partners

This course introduces the Lenovo data center portfolio, and covers servers, storage, storage networking, and software-defined infrastructure products. After completing this course about Lenovo data center products, you will be able to identify product types within each data center family, describe Lenovo innovations that this product family or category uses, and recognize when a specific product should be selected.

Published: 2024-05-29

Length: 20 minutes

Start the training:

Employee link: Grow@Lenovo

Partner link: [Lenovo Partner Learning](#)

Course code: SXXW1110r7

12. **VTT Cloud Architecture: NVIDIA Using Cloud for GPUs and AI**

2024-05-22 | 60 minutes | Employees Only

Join JD Dupont, NVIDIA Head of Americas Sales, Lenovo partnership and Veer Mehta, NVIDIA Solution Architect on an interactive discussion about cloud to edge, designing cloud Solutions with NVIDIA GPUs and minimizing private\hybrid cloud OPEX with GPUs. Discover how you can use what is done at big public cloud providers for your customers. We will also walk through use cases and see a demo you can use to help your customers.

Published: 2024-05-22

Length: 60 minutes

Start the training:

Employee link: Grow@Lenovo

Course code: DVCLD212

13. **Partner Technical Webinar - ISG Portfolio Update**
2024-04-15 | 60 minutes | Employees and Partners

In this 60-minute replay, Mark Bica, NA ISG Server Product Manager reviewed the Lenovo ISG portfolio. He covered new editions such as the SR680a \ SR685a, dense servers, and options that are strategic for any workload.

Published: 2024-04-15
Length: 60 minutes

Start the training:
Employee link: [Grow@Lenovo](#)
Partner link: [Lenovo Partner Learning](#)

Course code: 041224

14. **Partner Technical Webinar - StorMagic**
2024-03-19 | 60 minutes | Employees and Partners

March 08, 2024 – In this 60-minute replay, Stuart Campbell and Wes Ganeko of StorMagic joined us and provided an overview of StorMagic on Lenovo. They also demonstrated the interface while sharing some interesting use cases.

Published: 2024-03-19
Length: 60 minutes

Start the training:
Employee link: [Grow@Lenovo](#)
Partner link: [Lenovo Partner Learning](#)

Course code: 030824

15. **Family Portfolio: Storage Controller Options**
2024-01-23 | 25 minutes | Employees and Partners

This course covers the storage controller options available for use in Lenovo servers. The classes of storage controller are discussed, along with a discussion of where they are used, and which to choose.

After completing this course, you will be able to:

- Describe the classes of storage controllers
- Discuss where each controller class is used
- Describe the available options in each controller class

Published: 2024-01-23
Length: 25 minutes

Start the training:
Employee link: [Grow@Lenovo](#)
Partner link: [Lenovo Partner Learning](#)

Course code: SXXW1111

16. **Lenovo-Intel Sustainable Solutions QH**
2024-01-22 | 10 minutes | Employees and Partners

This Quick Hit explains how Lenovo and Intel are committed to sustainability, and introduces the Lenovo-Intel joint sustainability campaign. You will learn how to use this campaign to show customers what that level of commitment entails, how to use the campaign's unsolicited proposal approach, and how to use the campaign as a conversation starter which may lead to increased sales.

Published: 2024-01-22
Length: 10 minutes

Start the training:

Employee link: [Grow@Lenovo](#)
Partner link: [Lenovo Partner Learning](#)

Course code: SXXW2524a

17. **FY24Q3 Intel Servers Update**
2023-12-11 | 15 minutes | Employees and Partners

This update is designed to help you discuss the features and customer benefits of Lenovo servers that use the 5th Gen Intel® Xeon® processors. Lenovo has also introduced a new server, the ThinkSystem SD650-N V3, which expands the supercomputer server family. Reasons to call your customer and talk about refreshing their infrastructure are also included as a guideline.

Published: 2023-12-11
Length: 15 minutes

Start the training:

Employee link: [Grow@Lenovo](#)
Partner link: [Lenovo Partner Learning](#)

Course code: SXXW2522a

18. **Partner Technical Webinar - Data Center Limits and ISG TAA Compliance**
2023-05-16 | 60 minutes | Employees and Partners

In this 60-minute replay, we had two topics. First Vinod Kamath, Lenovo Distinguished Engineer for Data Center Cooling presented on the Systems Configuration and Data Center Ambient Limits. Second, Shama Patari, Lenovo Trade Council, and Glenn Johnson, Lenovo Principal Engineer for Supply Chain presented on ISG TAA Compliance.

Published: 2023-05-16
Length: 60 minutes

Start the training:

Employee link: [Grow@Lenovo](#)
Partner link: [Lenovo Partner Learning](#)

Course code: 051223

19. **Lenovo Sustainable Computing**
2022-09-16 | 4 minutes | Employees and Partners

This Quick Hit describes the Lenovo sustainable computing program, and the many ways in which Lenovo strives to respect and protect the environment.

Published: 2022-09-16
Length: 4 minutes

Start the training:
Employee link: [Grow@Lenovo](#)
Partner link: [Lenovo Partner Learning](#)

Course code: SXXW2504a

Related publications and links

For more information, see these resources:

- ThinkSystem ST45 V3 product page
<https://www.lenovo.com/us/en/p/servers-storage/servers/towers/lenovo-thinksystem-st45-v3/len21ts0040>
- ThinkSystem ST45 V3 interactive 3D tour
<https://lenovopress.lenovo.com/lp2102>
- ThinkSystem ST45 V3 drivers and support
<https://datacentersupport.lenovo.com/us/en/products/servers/thinksystem/st45v3/7dh5/downloads/driver-list/>
- ThinkSystem ST45 V3 product publications:
<http://thinksystem.lenovofiles.com/help/index.jsp>
 - Quick Start
 - Tower-to-Rack Conversion Kit Installation Instructions
 - Setup Guide
 - Maintenance Manual
 - Lenovo XClarity Provisioning Manager Lite User Guide
- ServerProven hardware compatibility:
<http://www.lenovo.com/us/en/serverproven>

Related product families

Product families related to this document are the following:

- [1-Socket Tower Servers](#)
- [ThinkSystem ST45 V3 Server](#)

Notices

Lenovo may not offer the products, services, or features discussed in this document in all countries. Consult your local Lenovo representative for information on the products and services currently available in your area. Any reference to a Lenovo product, program, or service is not intended to state or imply that only that Lenovo product, program, or service may be used. Any functionally equivalent product, program, or service that does not infringe any Lenovo intellectual property right may be used instead. However, it is the user's responsibility to evaluate and verify the operation of any other product, program, or service. Lenovo may have patents or pending patent applications covering subject matter described in this document. The furnishing of this document does not give you any license to these patents. You can send license inquiries, in writing, to:

Lenovo (United States), Inc.
8001 Development Drive
Morrisville, NC 27560
U.S.A.
Attention: Lenovo Director of Licensing

LENOVO PROVIDES THIS PUBLICATION "AS IS" WITHOUT WARRANTY OF ANY KIND, EITHER EXPRESS OR IMPLIED, INCLUDING, BUT NOT LIMITED TO, THE IMPLIED WARRANTIES OF NON-INFRINGEMENT, MERCHANTABILITY OR FITNESS FOR A PARTICULAR PURPOSE. Some jurisdictions do not allow disclaimer of express or implied warranties in certain transactions, therefore, this statement may not apply to you.

This information could include technical inaccuracies or typographical errors. Changes are periodically made to the information herein; these changes will be incorporated in new editions of the publication. Lenovo may make improvements and/or changes in the product(s) and/or the program(s) described in this publication at any time without notice.

The products described in this document are not intended for use in implantation or other life support applications where malfunction may result in injury or death to persons. The information contained in this document does not affect or change Lenovo product specifications or warranties. Nothing in this document shall operate as an express or implied license or indemnity under the intellectual property rights of Lenovo or third parties. All information contained in this document was obtained in specific environments and is presented as an illustration. The result obtained in other operating environments may vary. Lenovo may use or distribute any of the information you supply in any way it believes appropriate without incurring any obligation to you.

Any references in this publication to non-Lenovo Web sites are provided for convenience only and do not in any manner serve as an endorsement of those Web sites. The materials at those Web sites are not part of the materials for this Lenovo product, and use of those Web sites is at your own risk. Any performance data contained herein was determined in a controlled environment. Therefore, the result obtained in other operating environments may vary significantly. Some measurements may have been made on development-level systems and there is no guarantee that these measurements will be the same on generally available systems. Furthermore, some measurements may have been estimated through extrapolation. Actual results may vary. Users of this document should verify the applicable data for their specific environment.

© Copyright Lenovo 2024. All rights reserved.

This document, LP1994, was created or updated on December 12, 2024.

Send us your comments in one of the following ways:

- Use the online Contact us review form found at:
<https://lenovopress.lenovo.com/LP1994>
- Send your comments in an e-mail to:
comments@lenovopress.com

This document is available online at <https://lenovopress.lenovo.com/LP1994>.

Trademarks

Lenovo and the Lenovo logo are trademarks or registered trademarks of Lenovo in the United States, other countries, or both. A current list of Lenovo trademarks is available on the Web at <https://www.lenovo.com/us/en/legal/copytrade/>.

The following terms are trademarks of Lenovo in the United States, other countries, or both:

Lenovo®

ServerProven®

System x®

ThinkAgile®

ThinkSystem®

XClarity®

The following terms are trademarks of other companies:

AMD and AMD EPYC™ are trademarks of Advanced Micro Devices, Inc.

Intel®, Pentium®, and Xeon® are trademarks of Intel Corporation or its subsidiaries.

Linux® is the trademark of Linus Torvalds in the U.S. and other countries.

Microsoft®, Hyper-V®, Windows Server®, and Windows® are trademarks of Microsoft Corporation in the United States, other countries, or both.

Other company, product, or service names may be trademarks or service marks of others.